



BATMAN



8-12

7785

Book 2



4499508





1

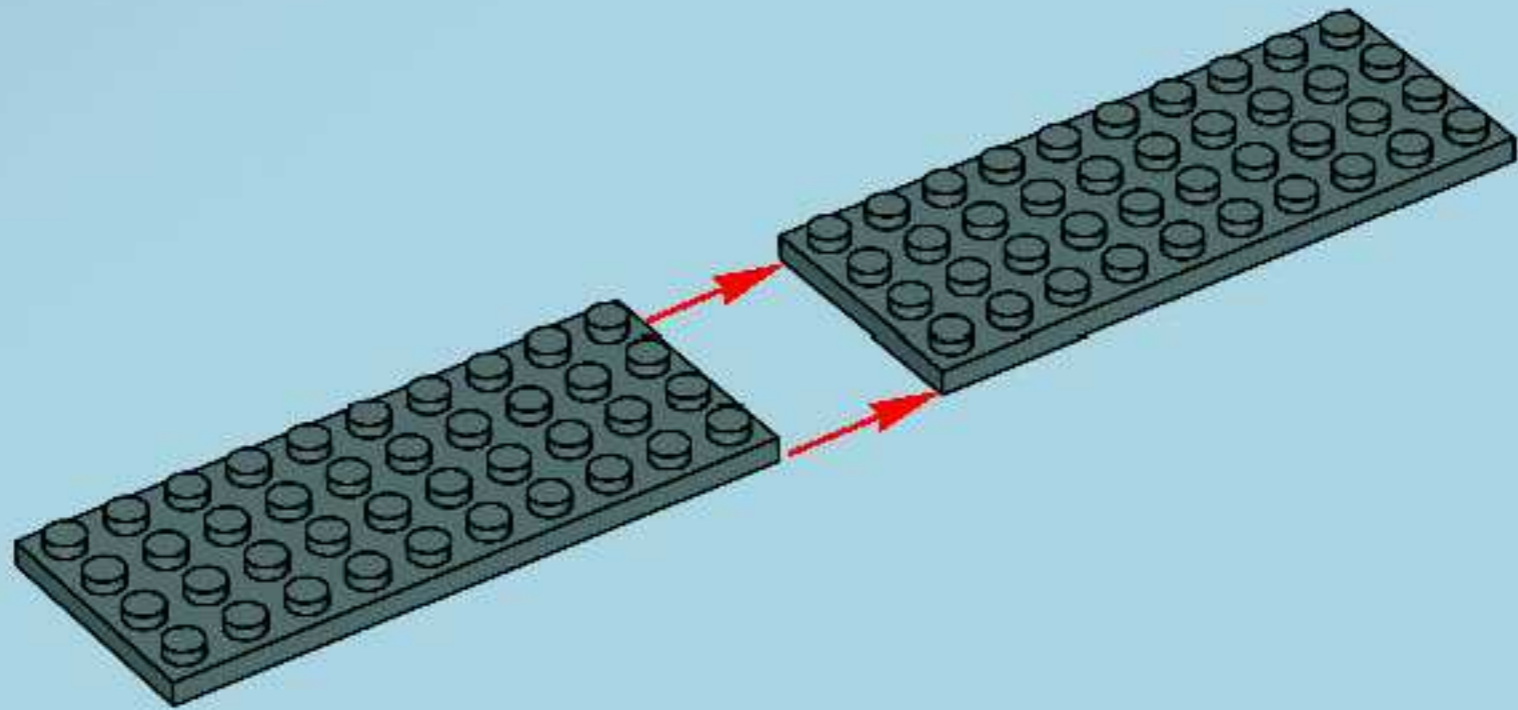

2

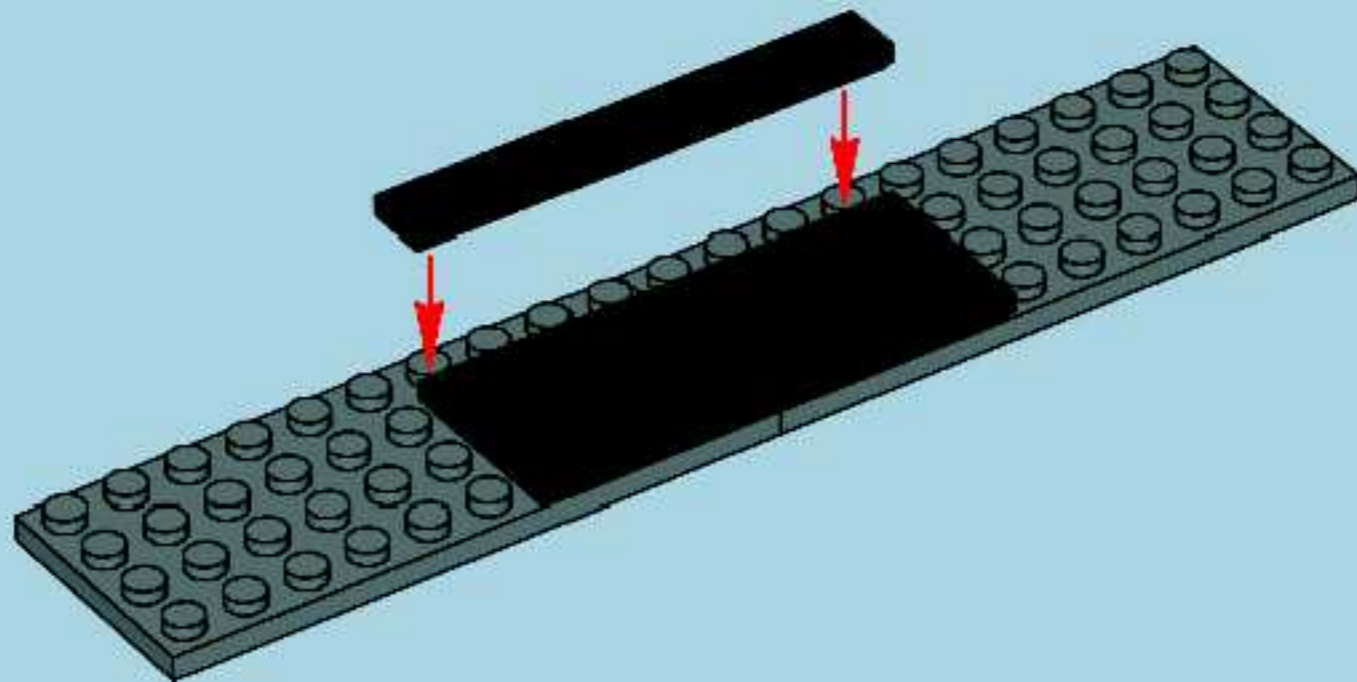

3

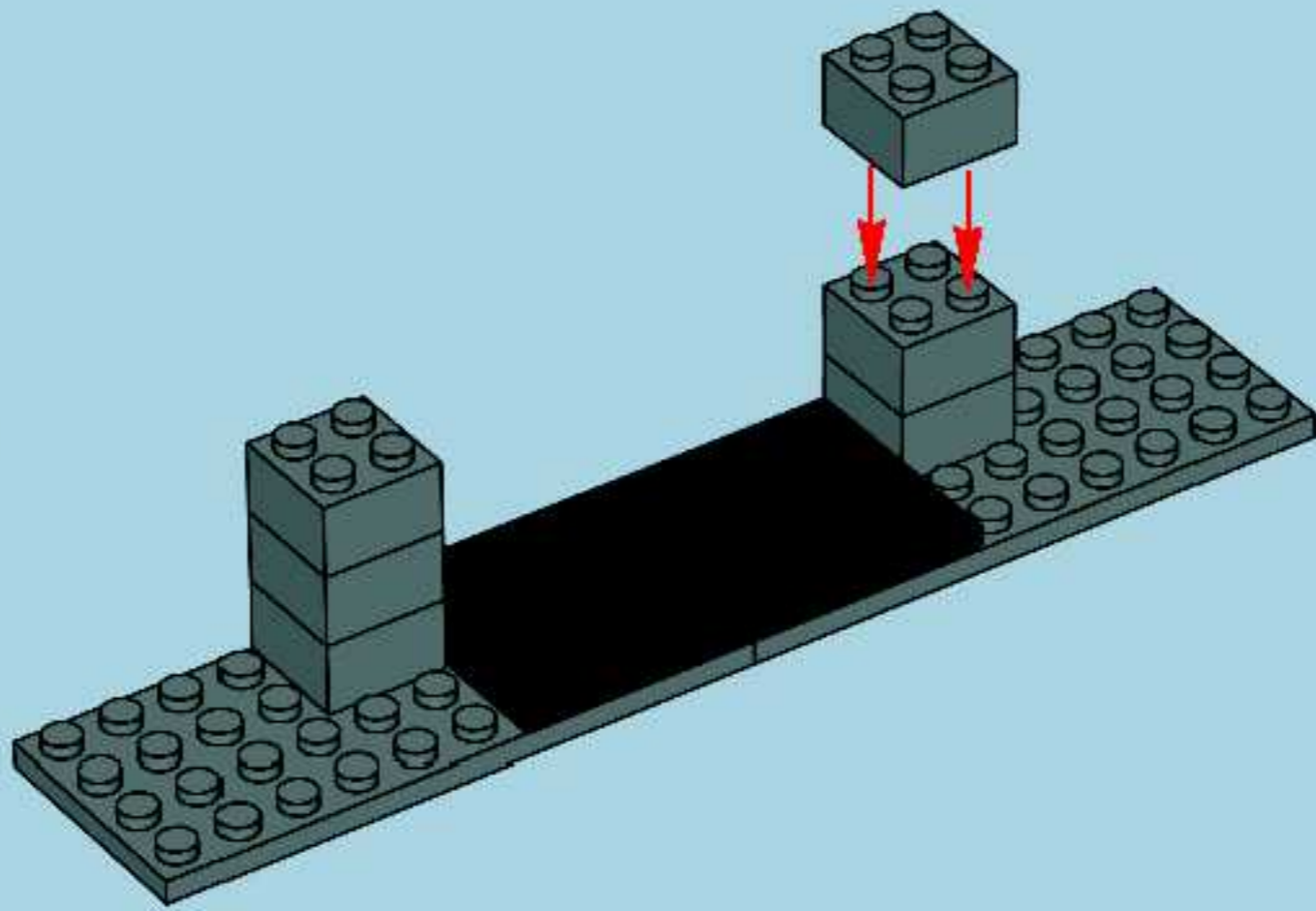

4

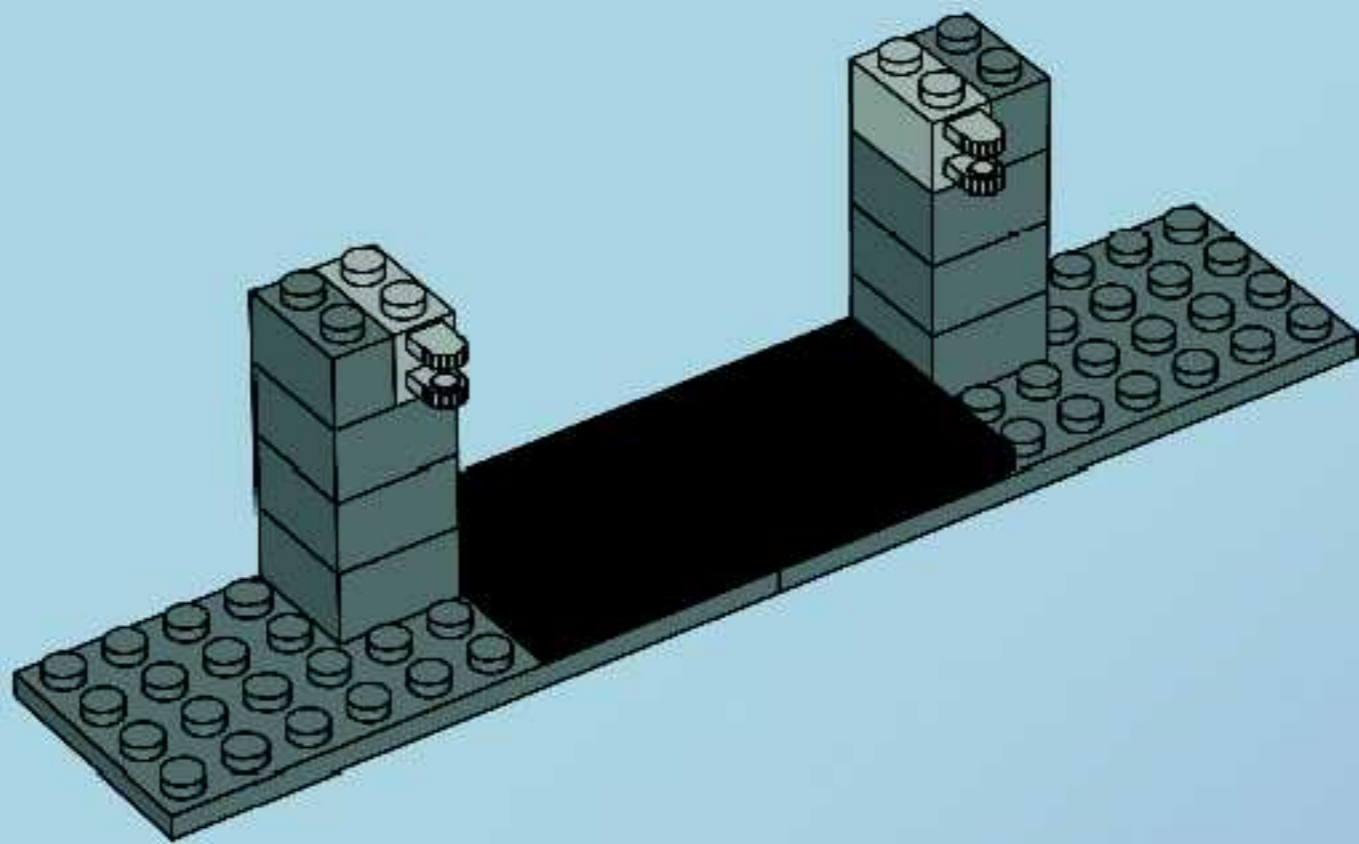

5

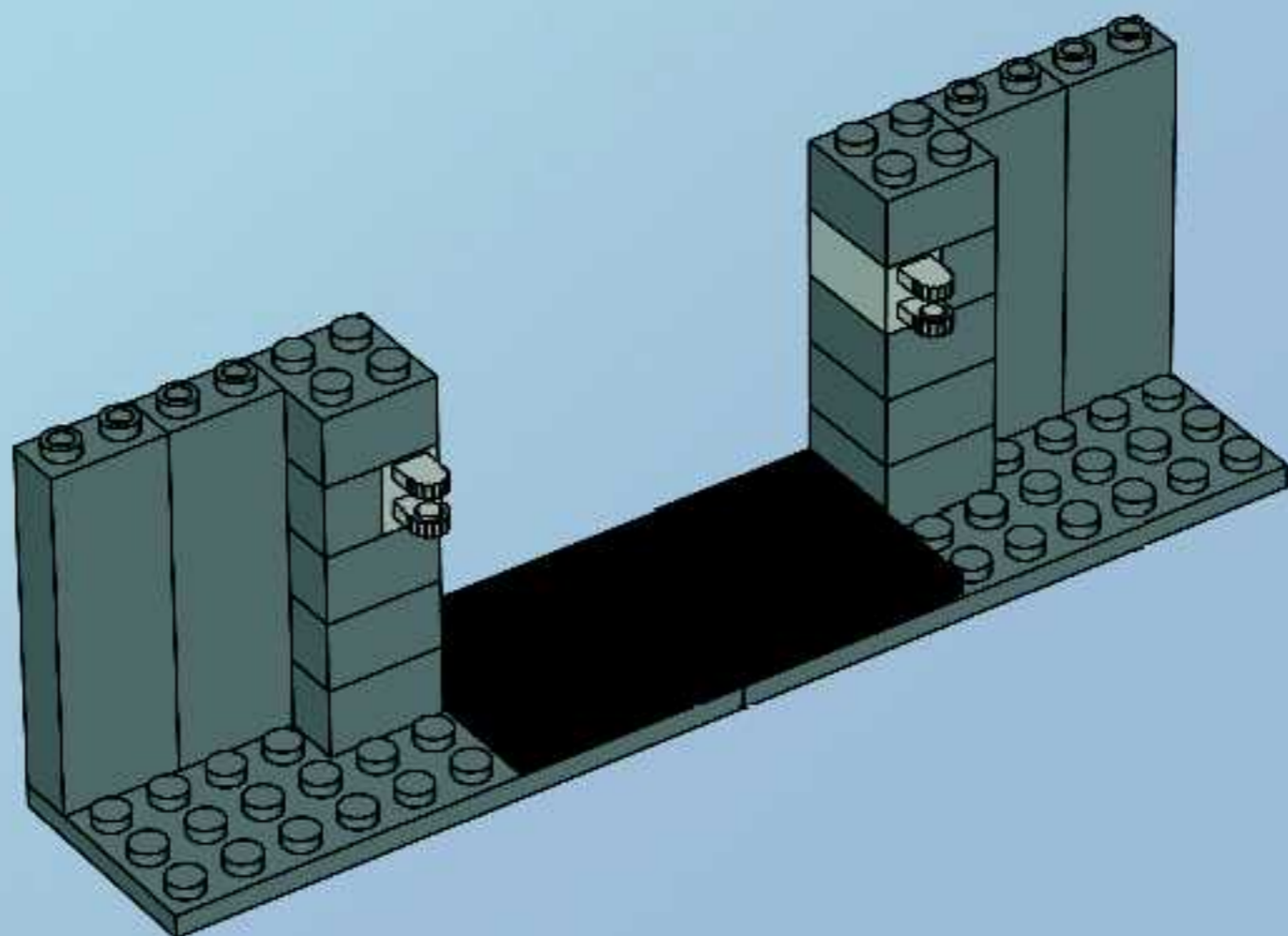

6

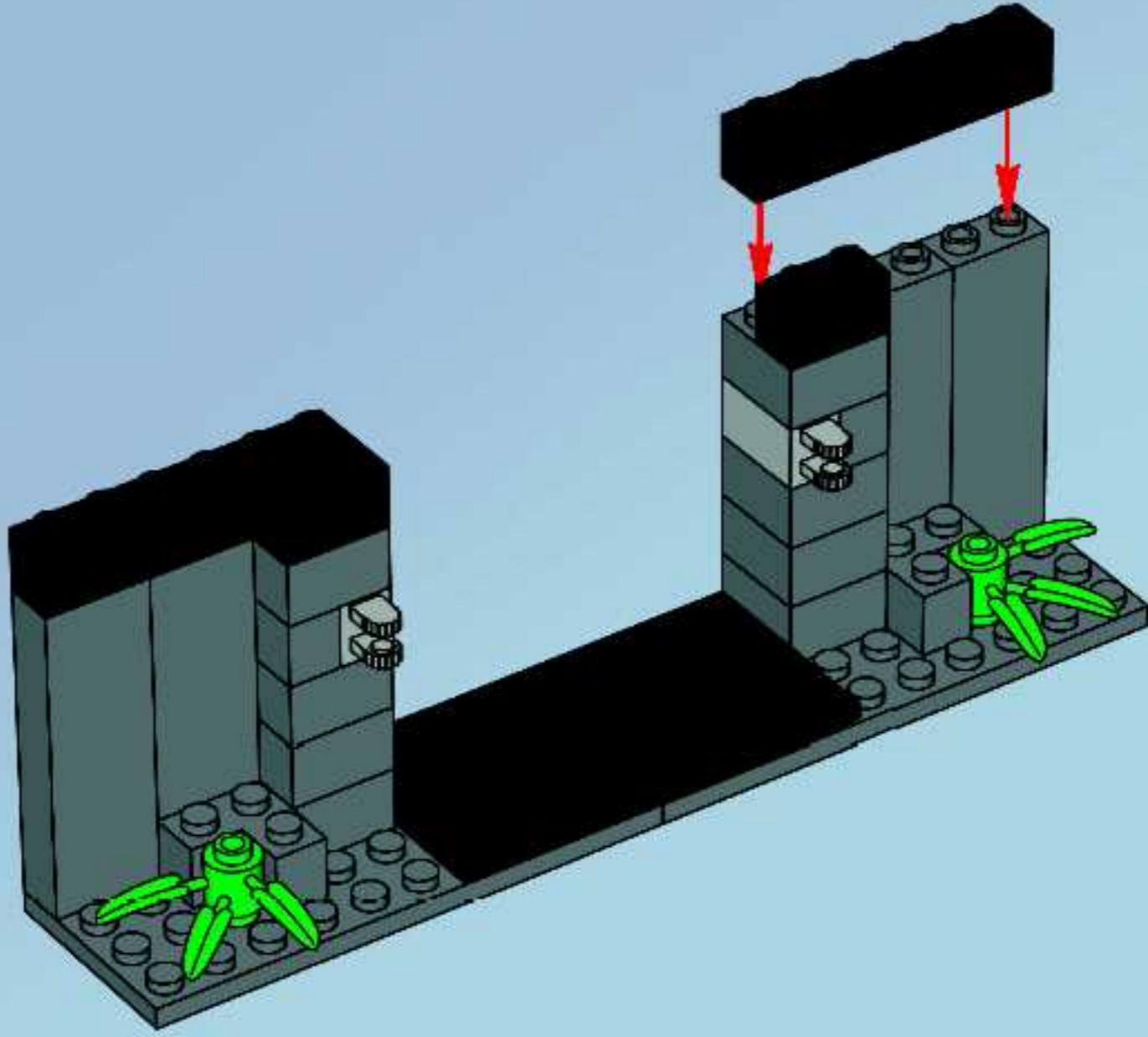

7

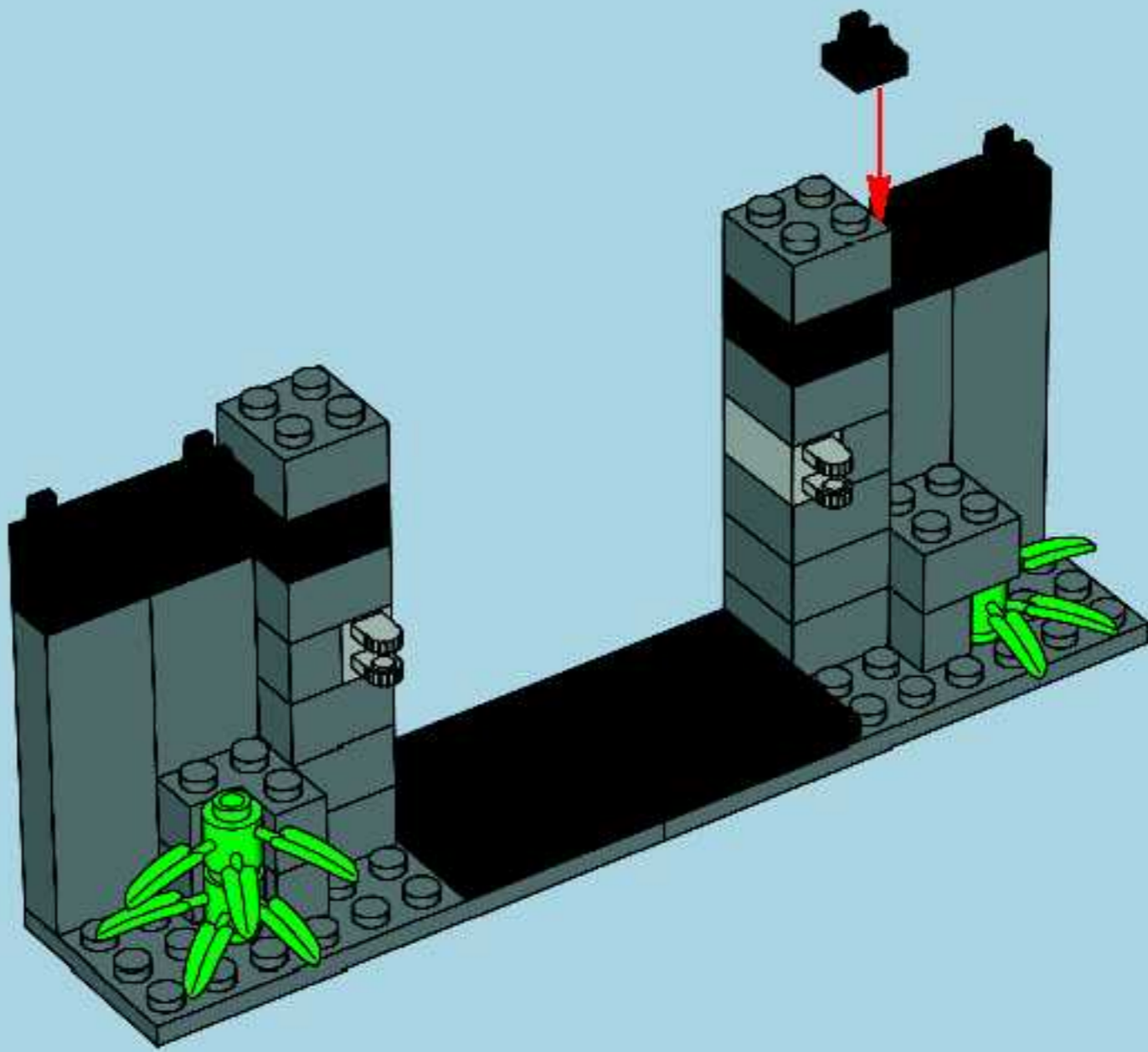

8

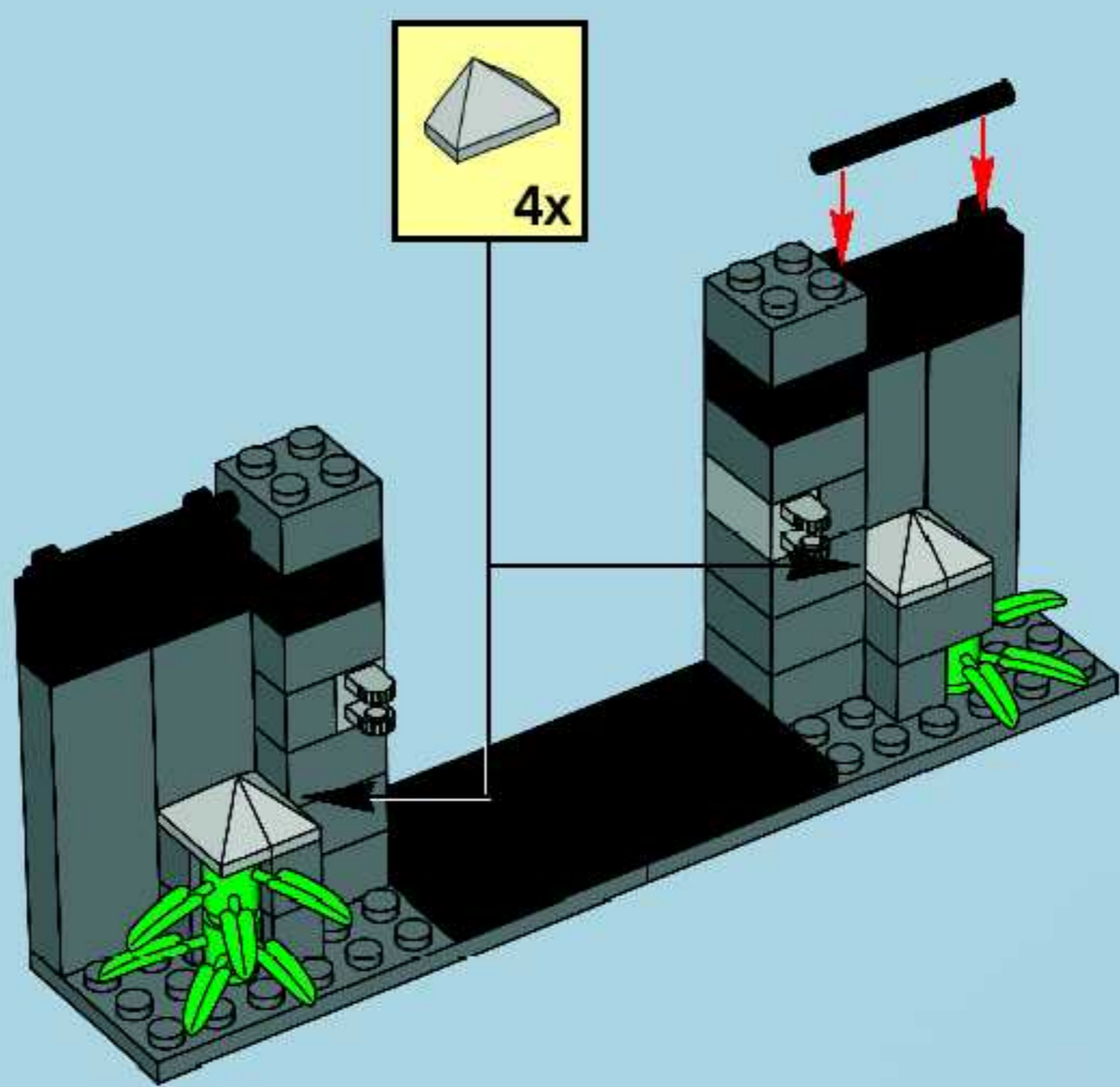

9

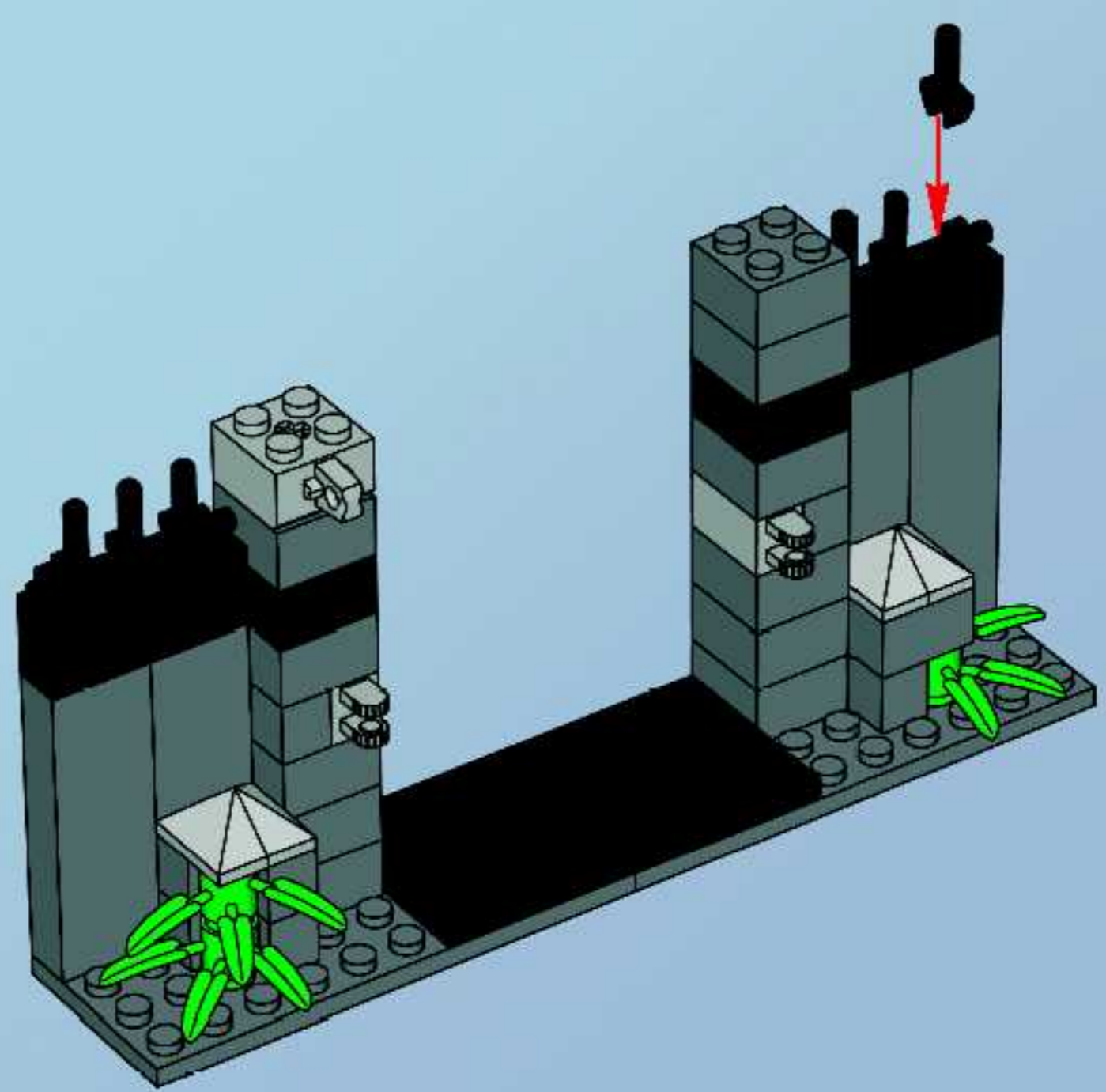

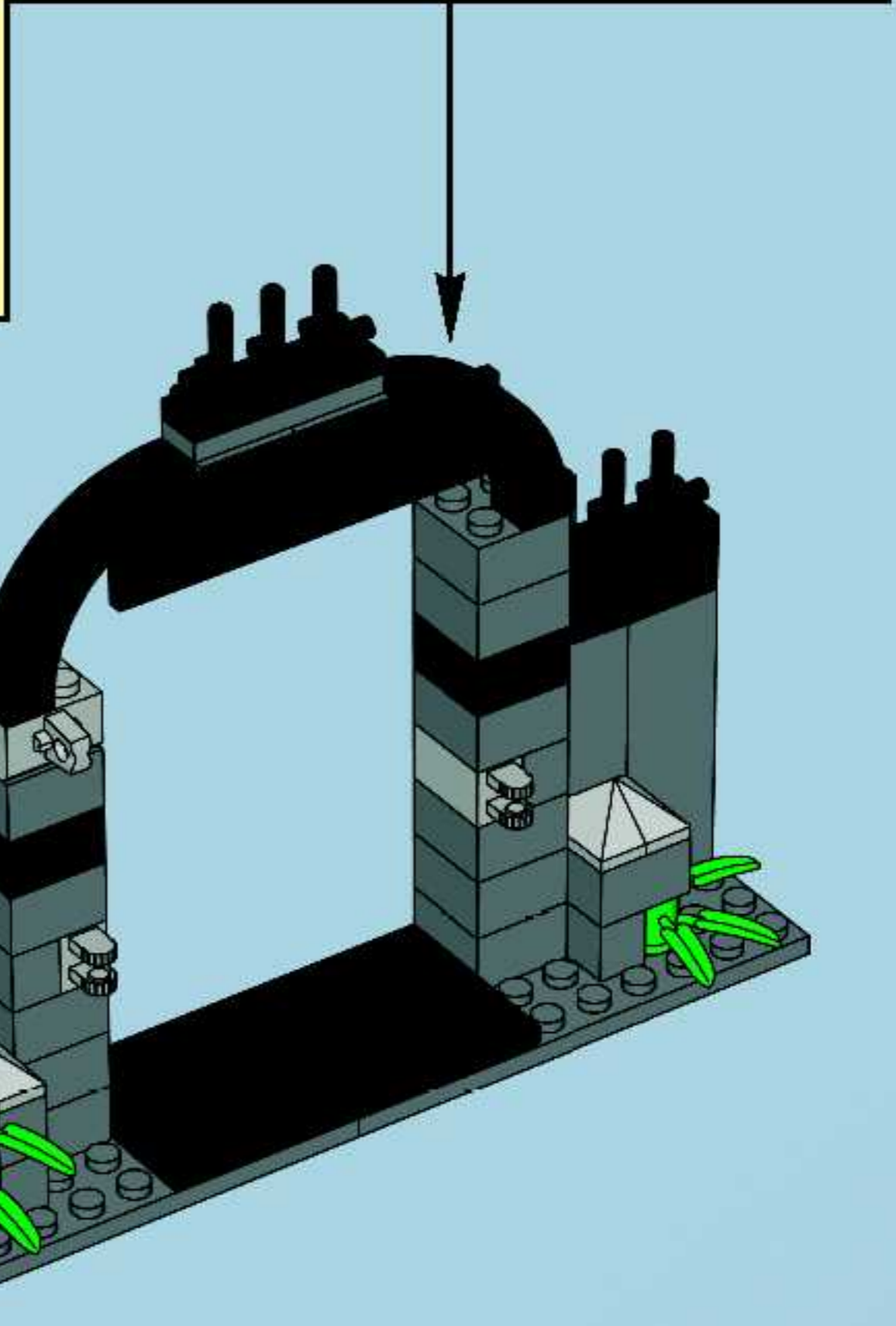
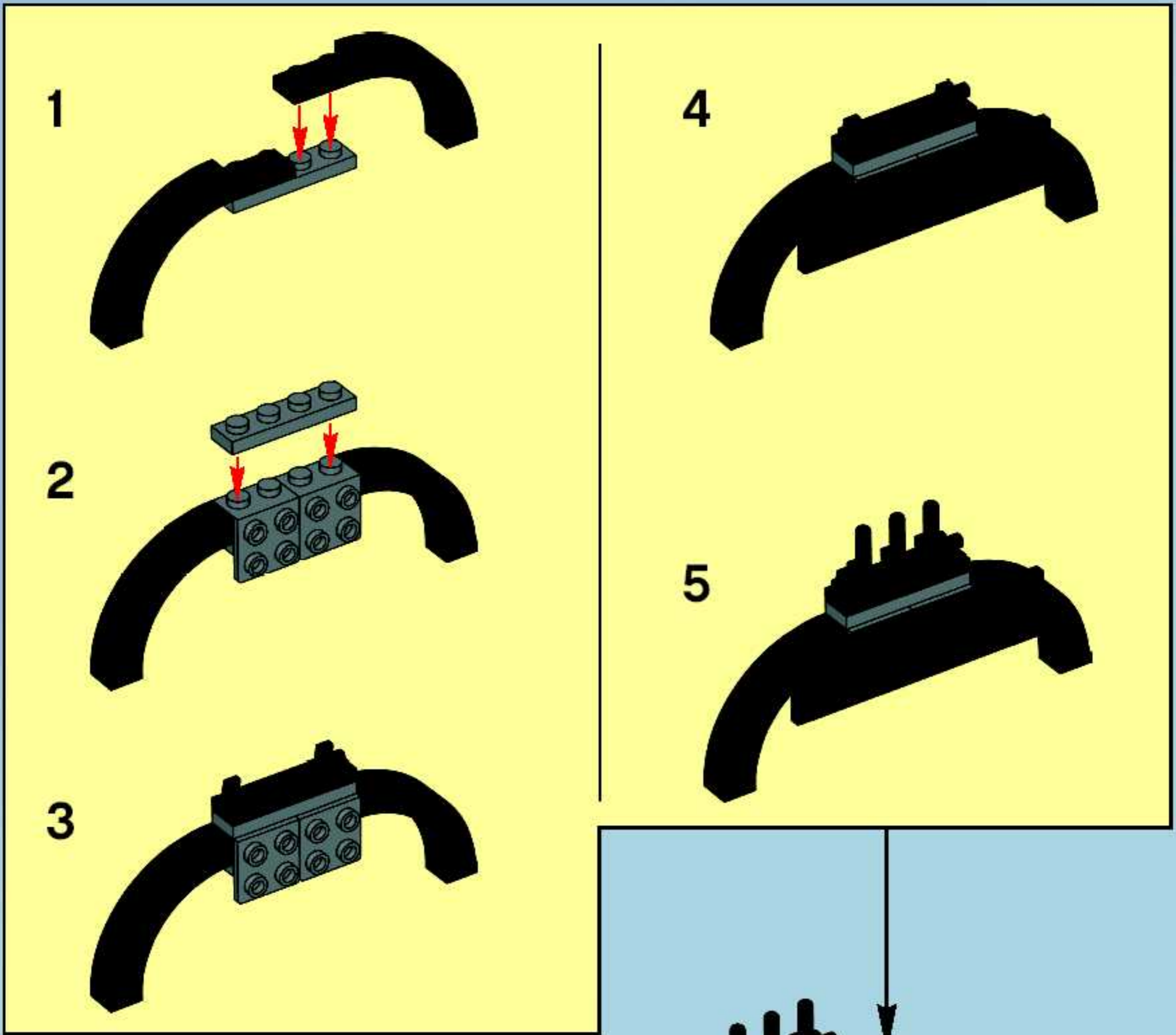

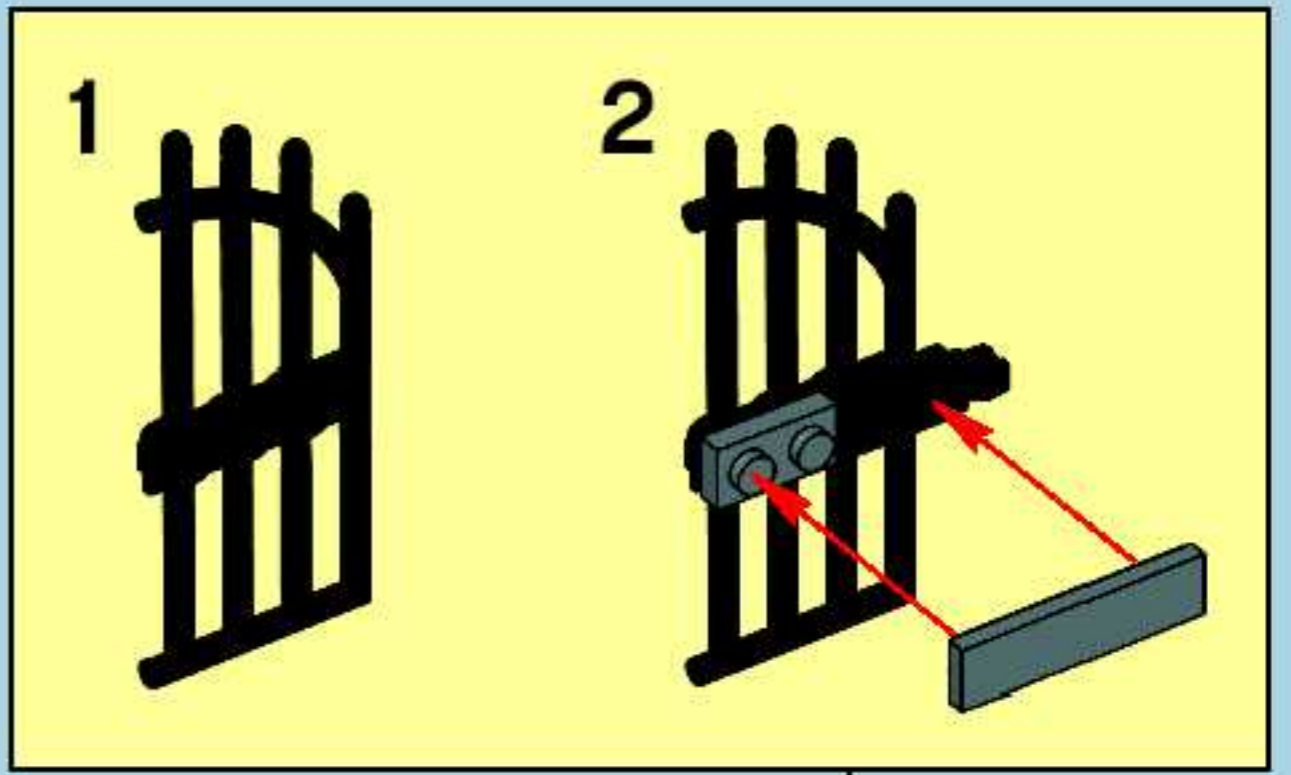

11

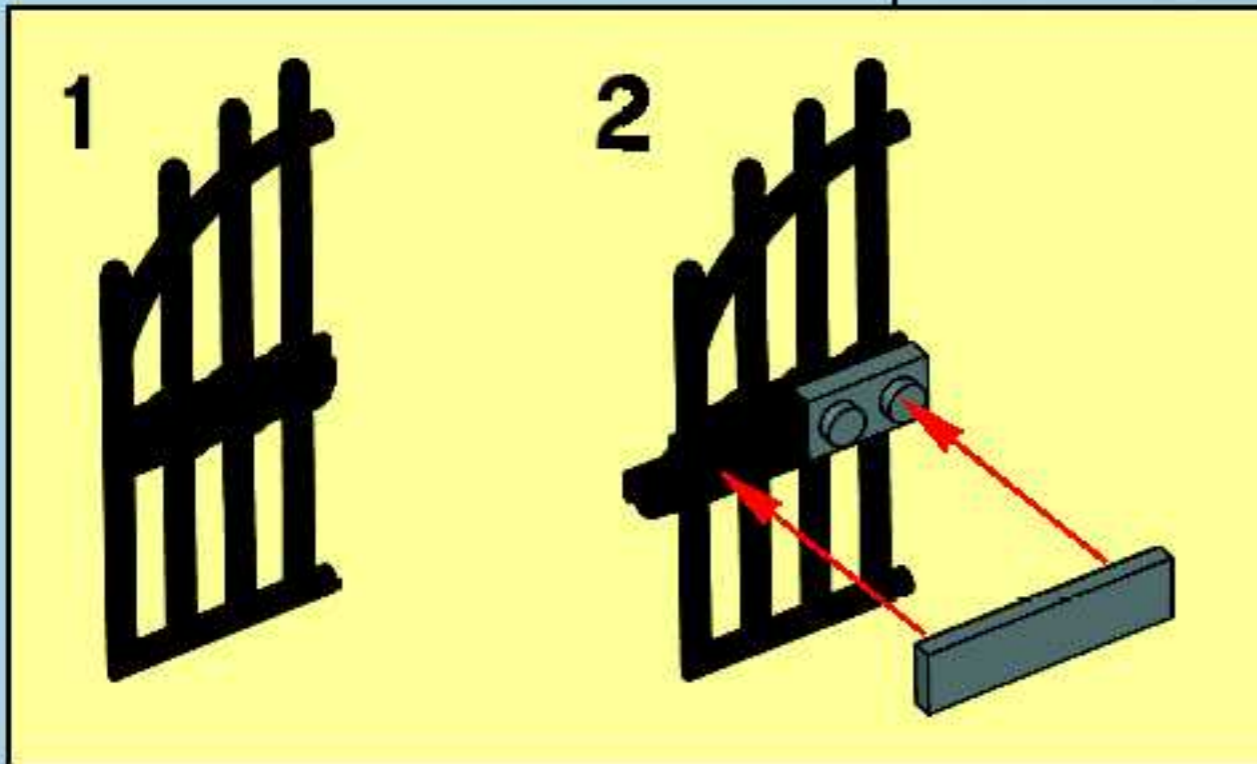
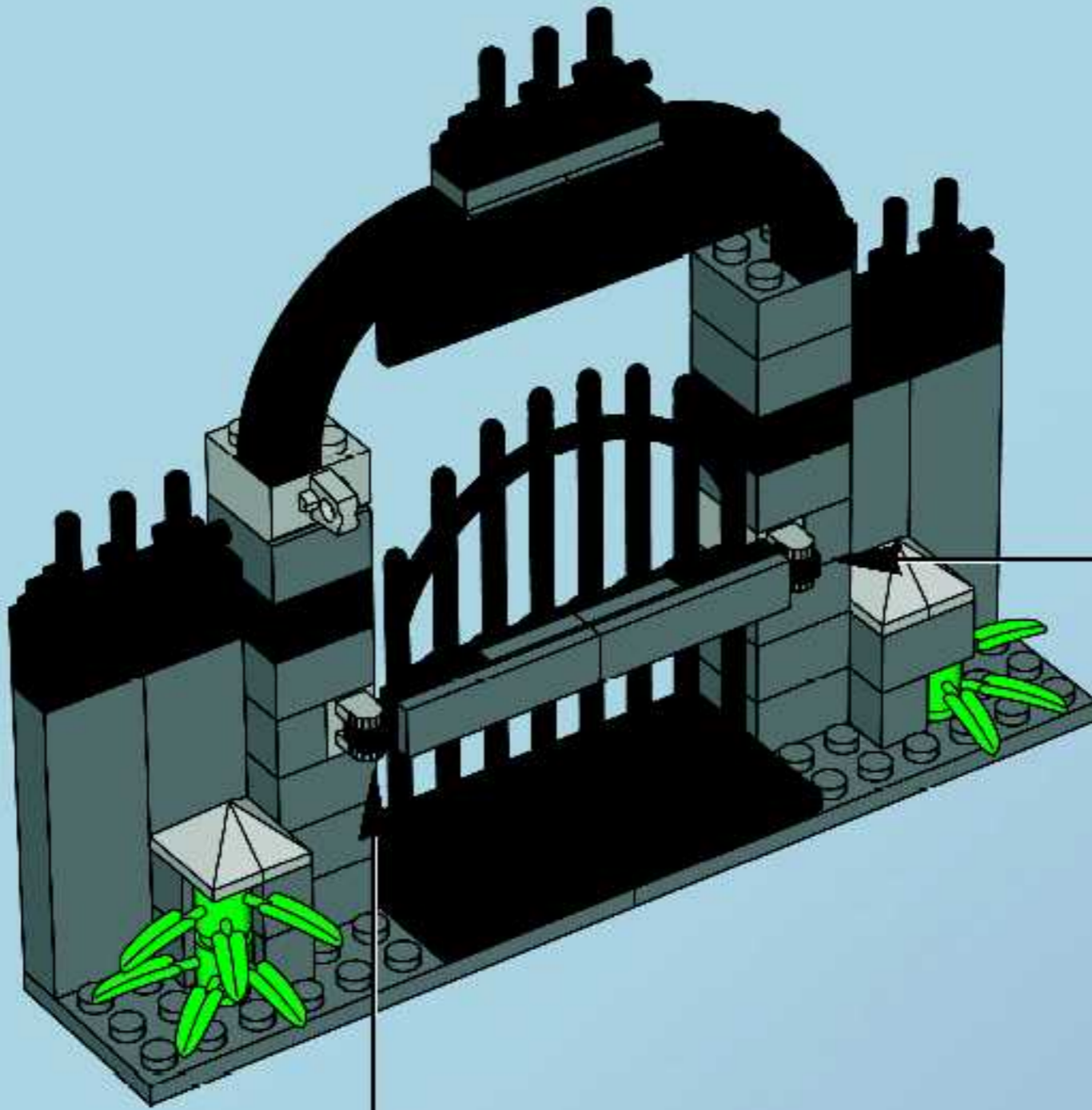

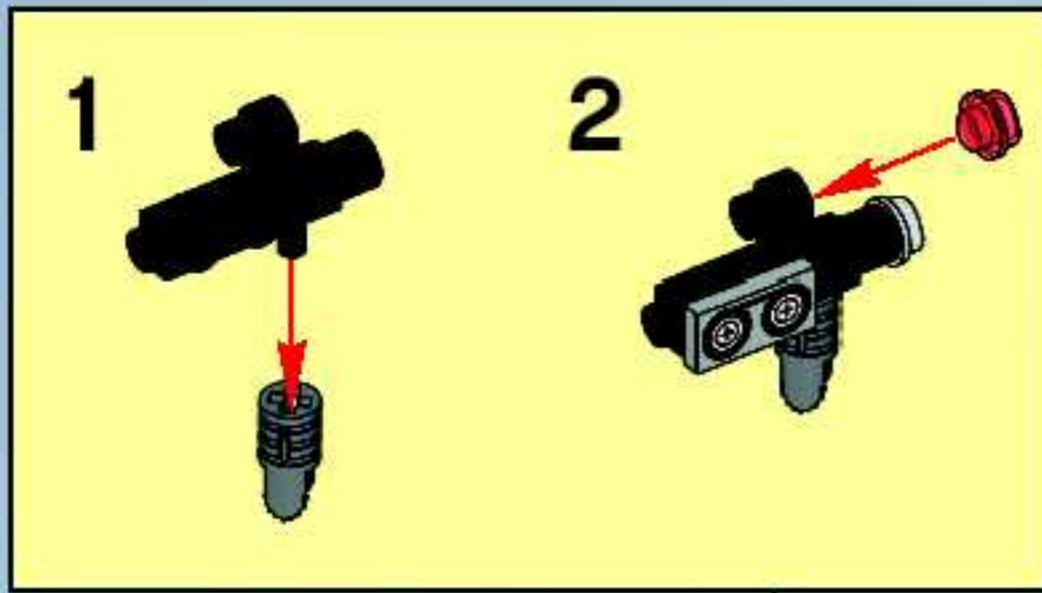

12

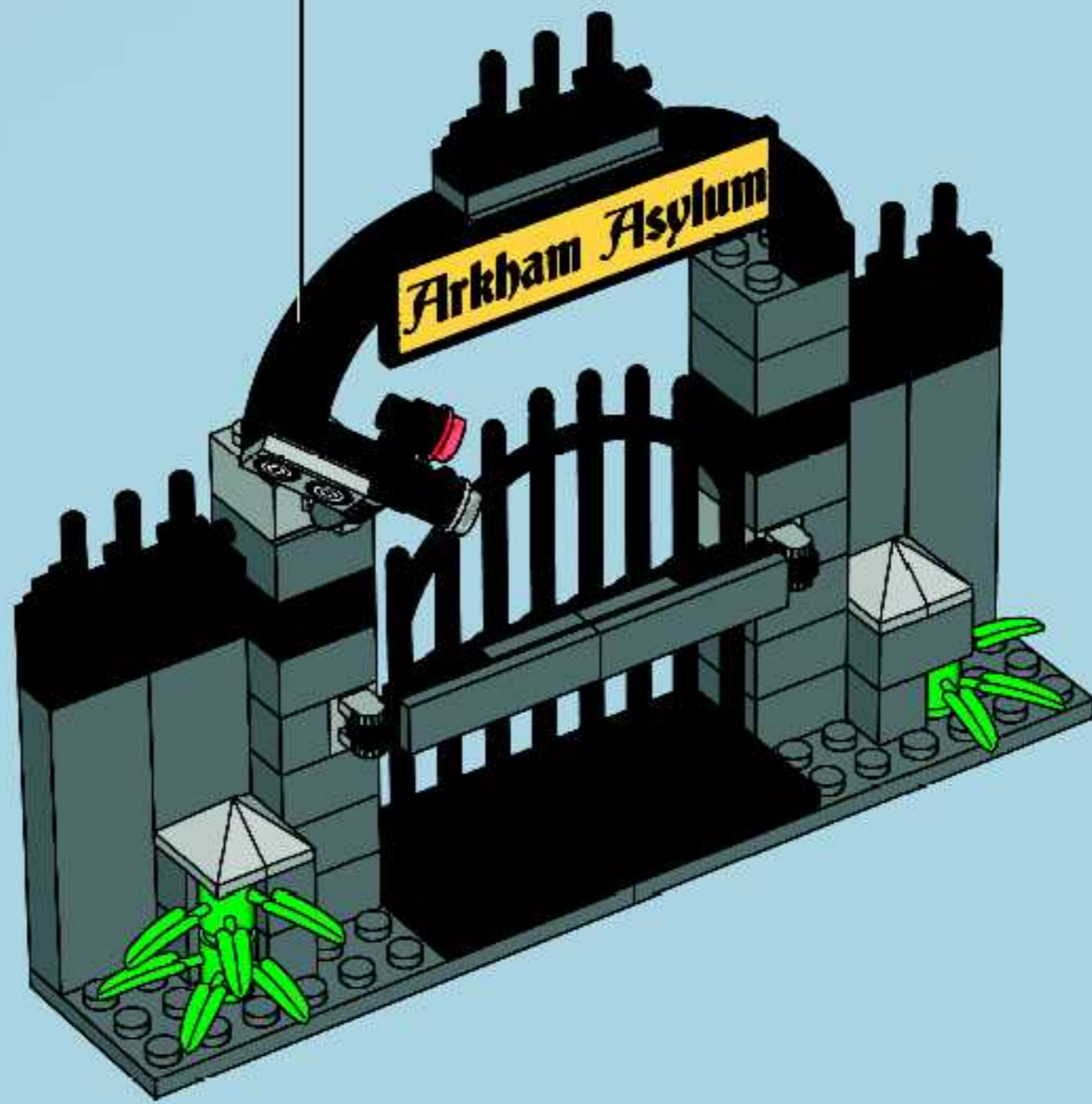

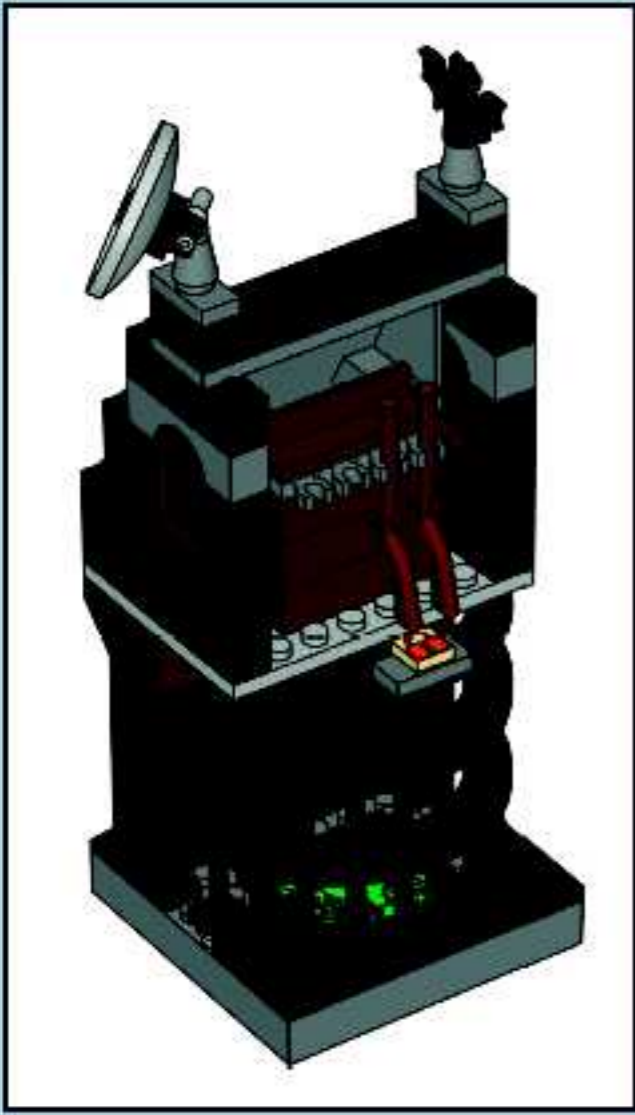

1

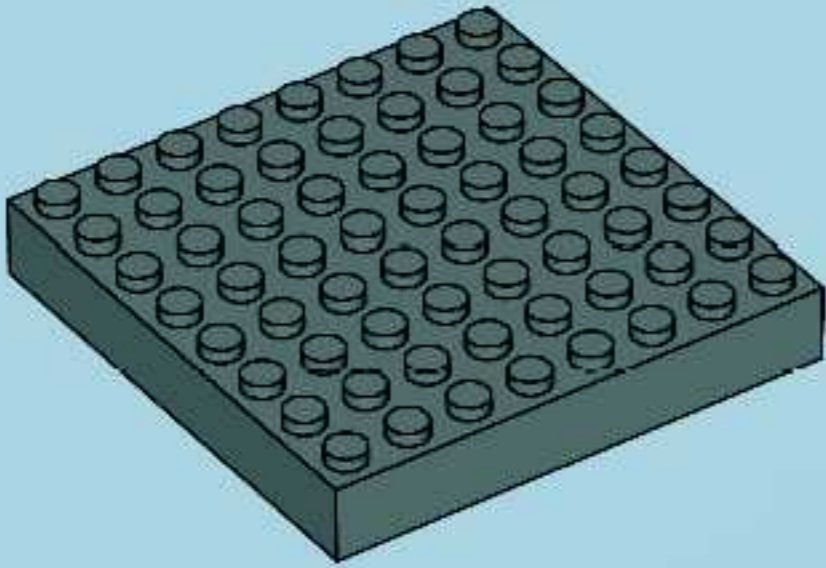

2

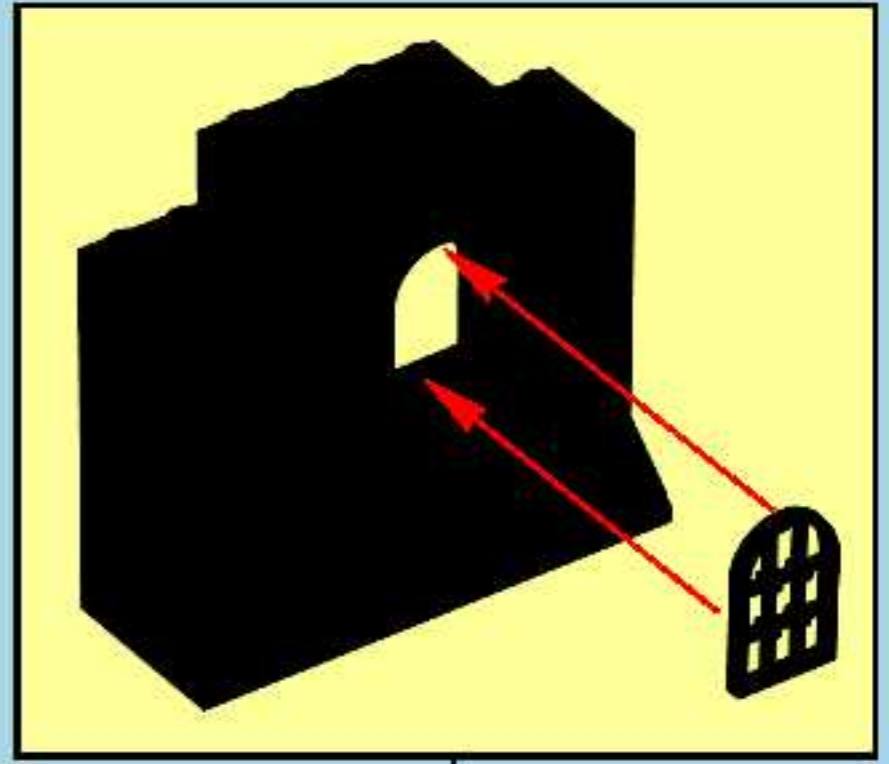
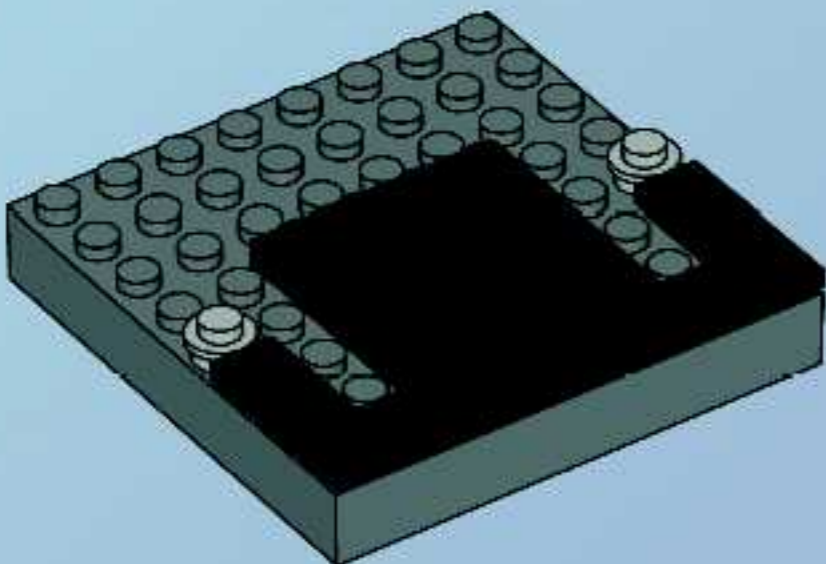

3

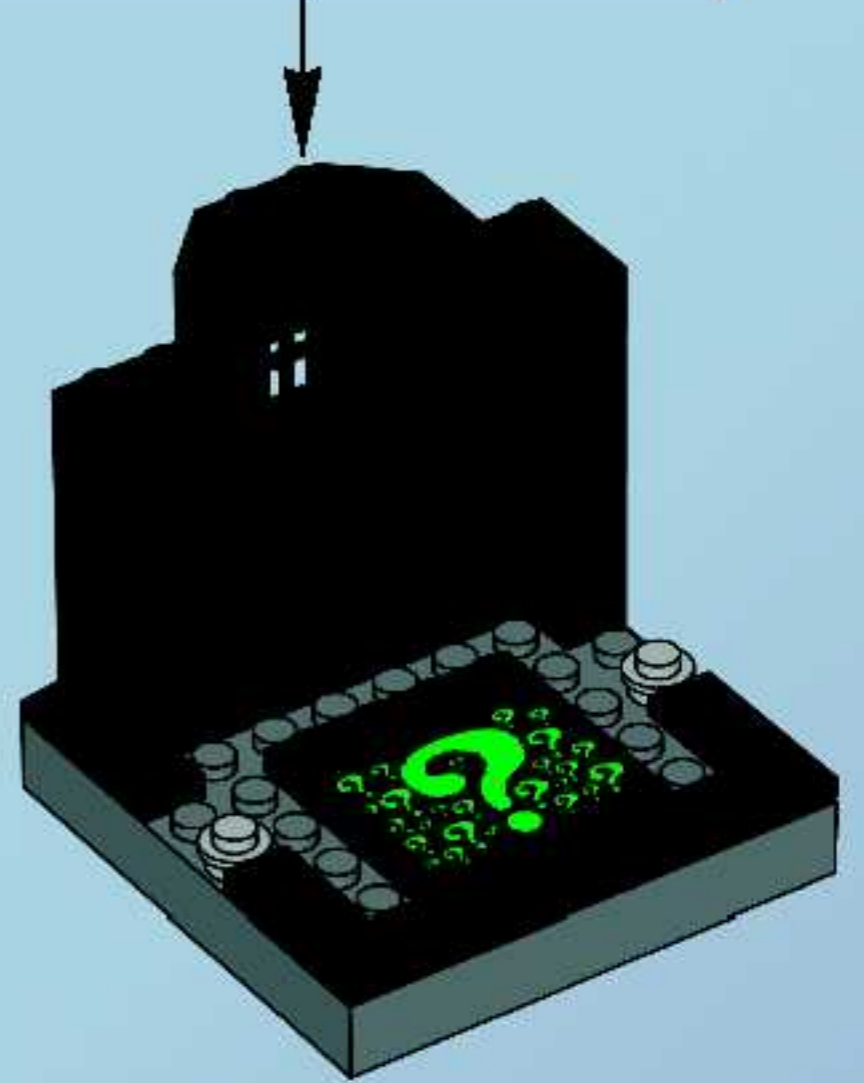

4

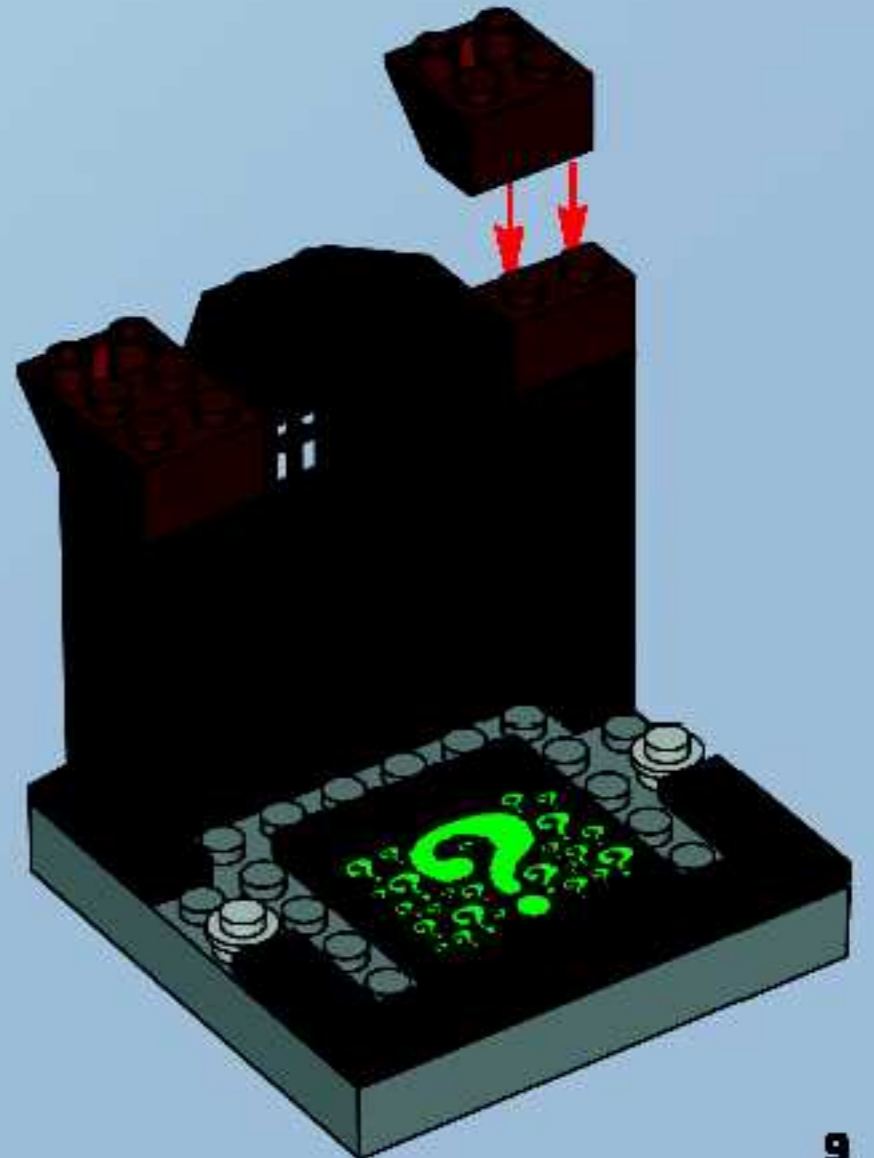

5

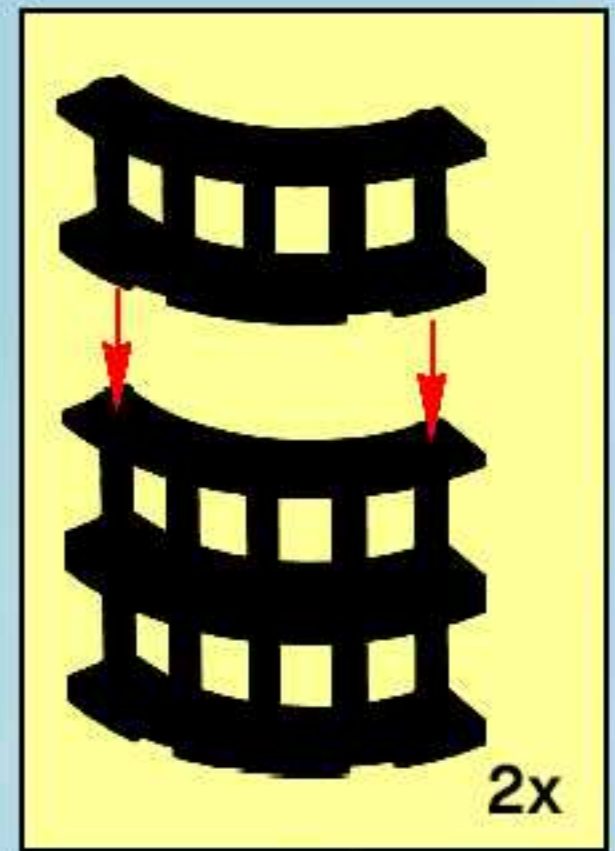
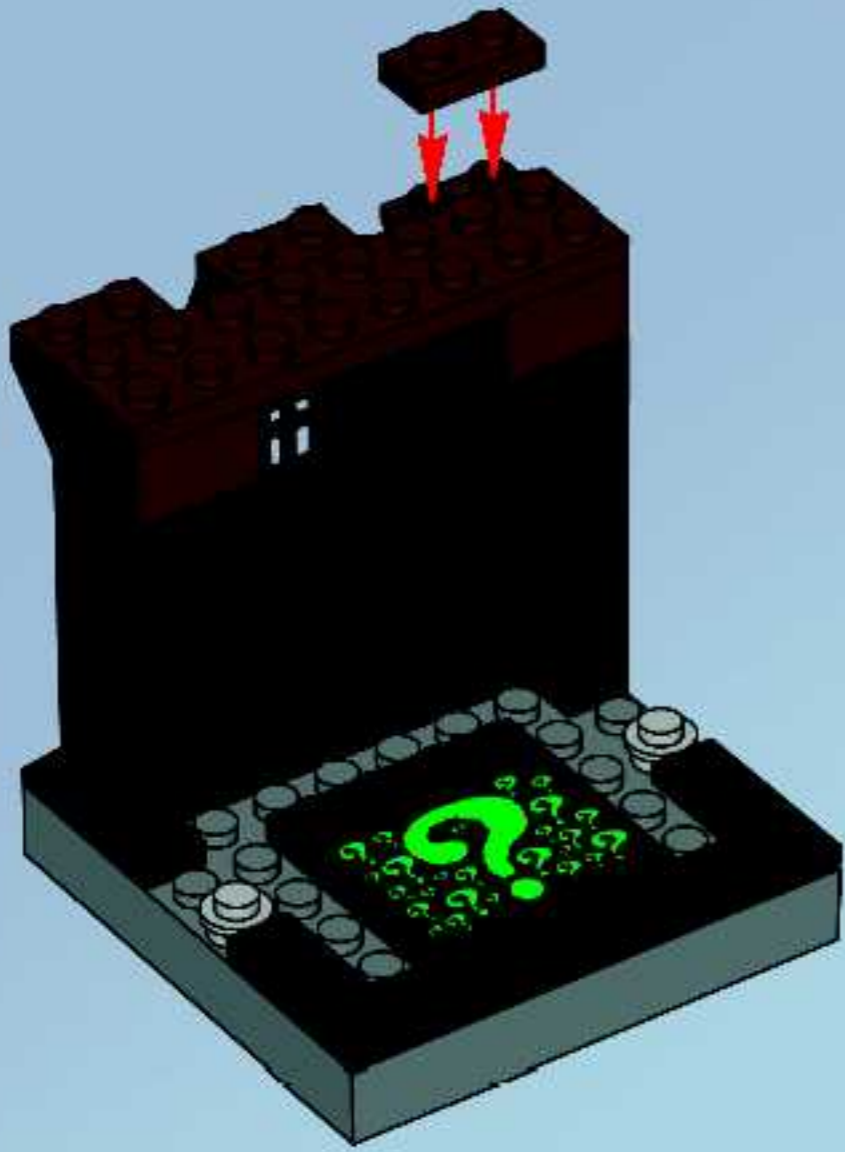

6

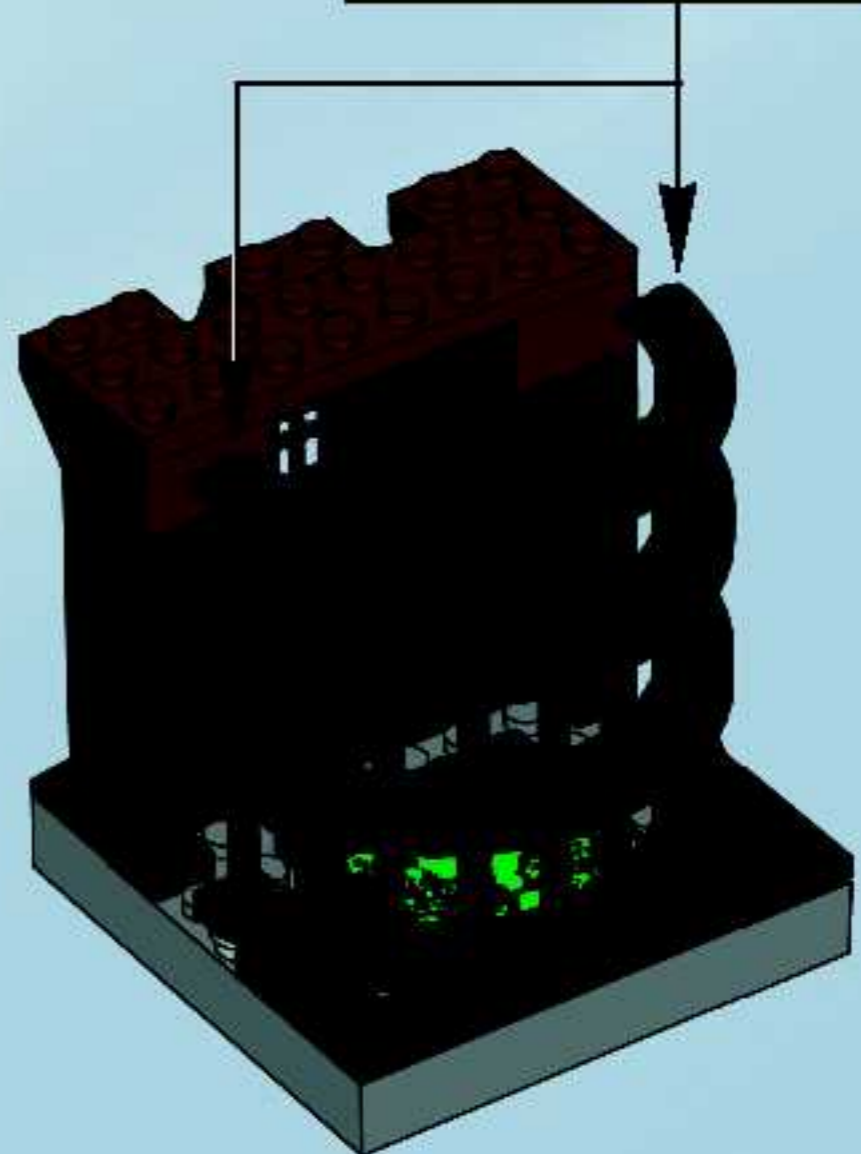

7

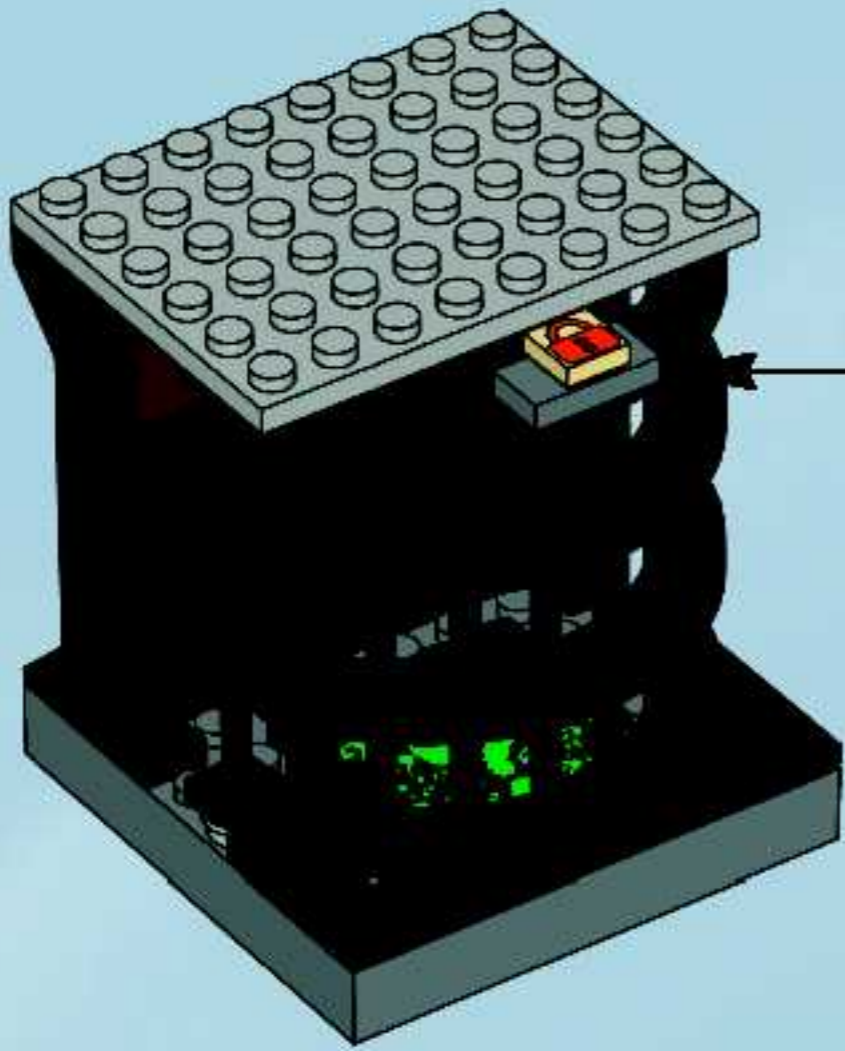

8

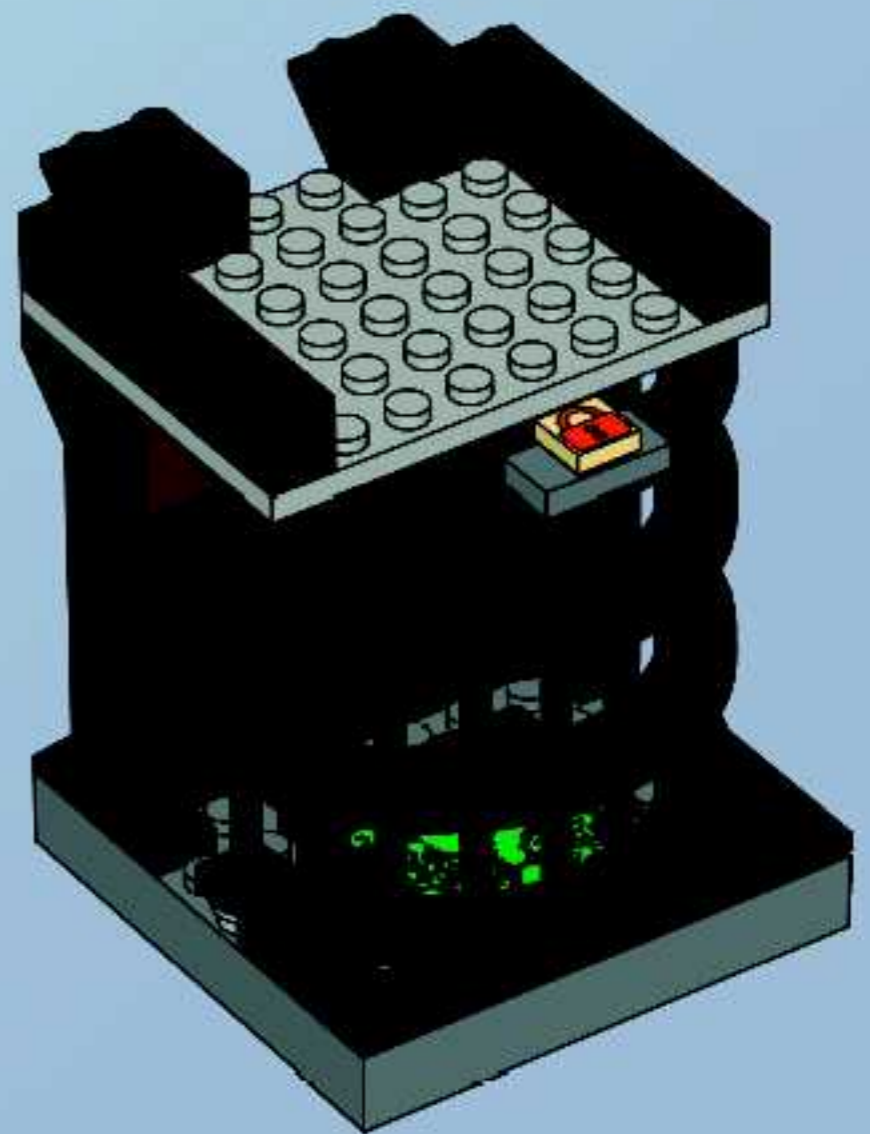

9

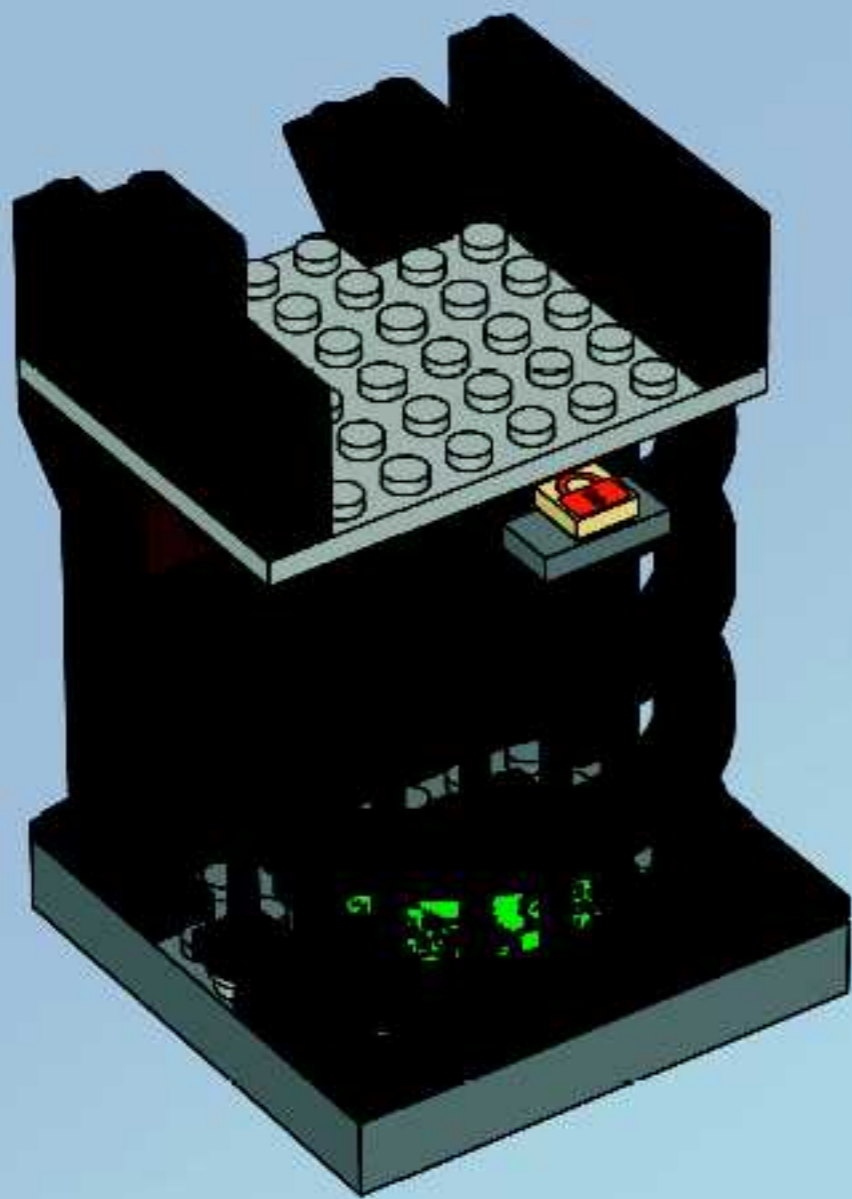

10

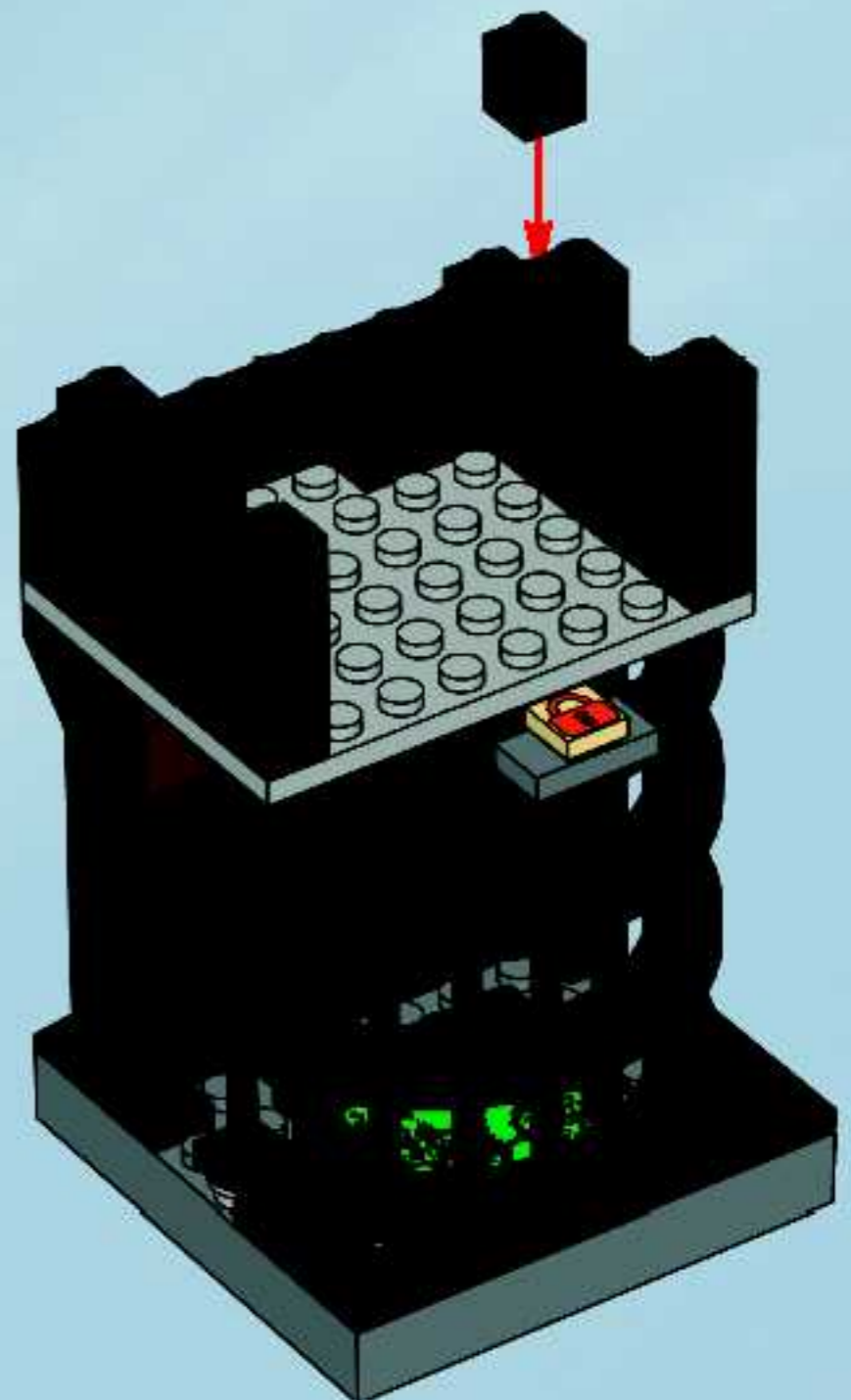

11

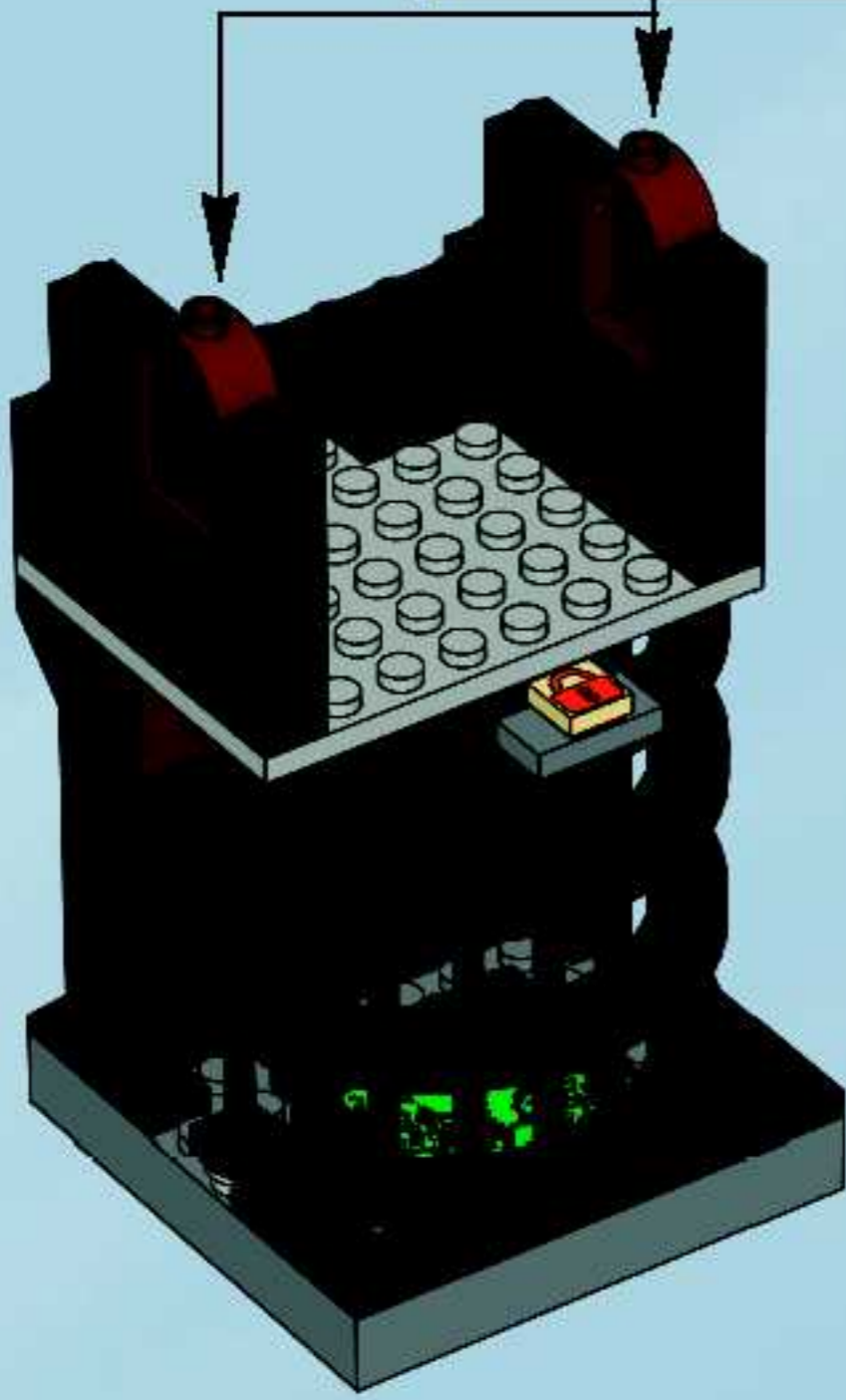
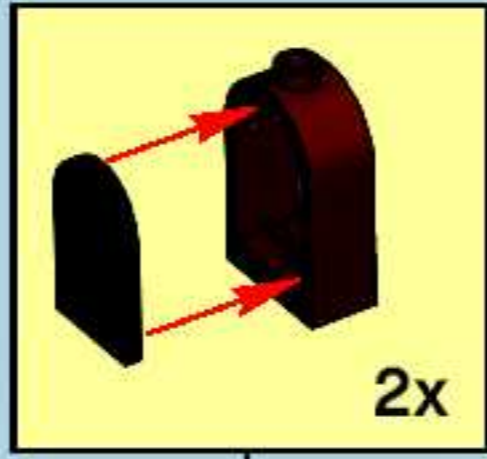

12

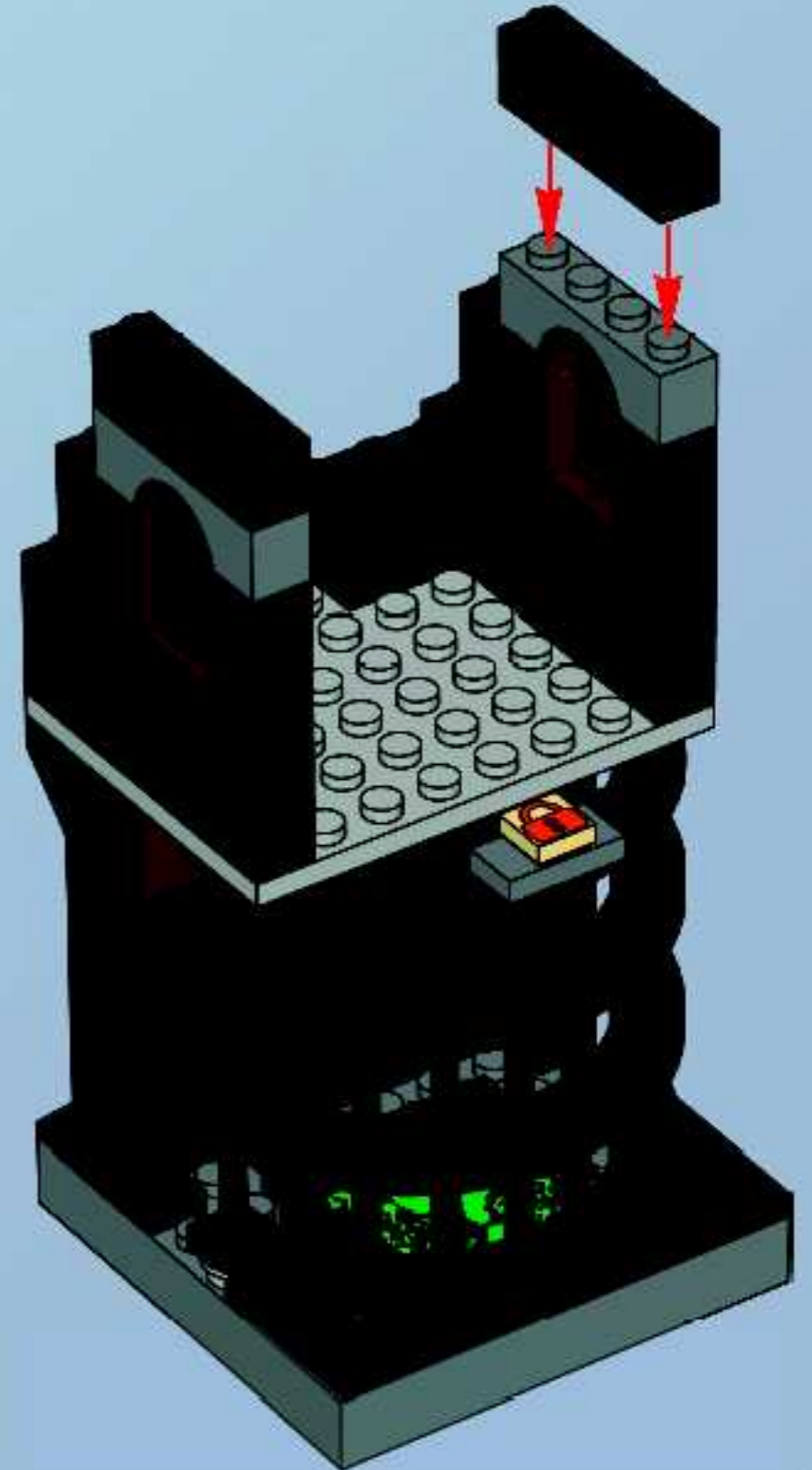

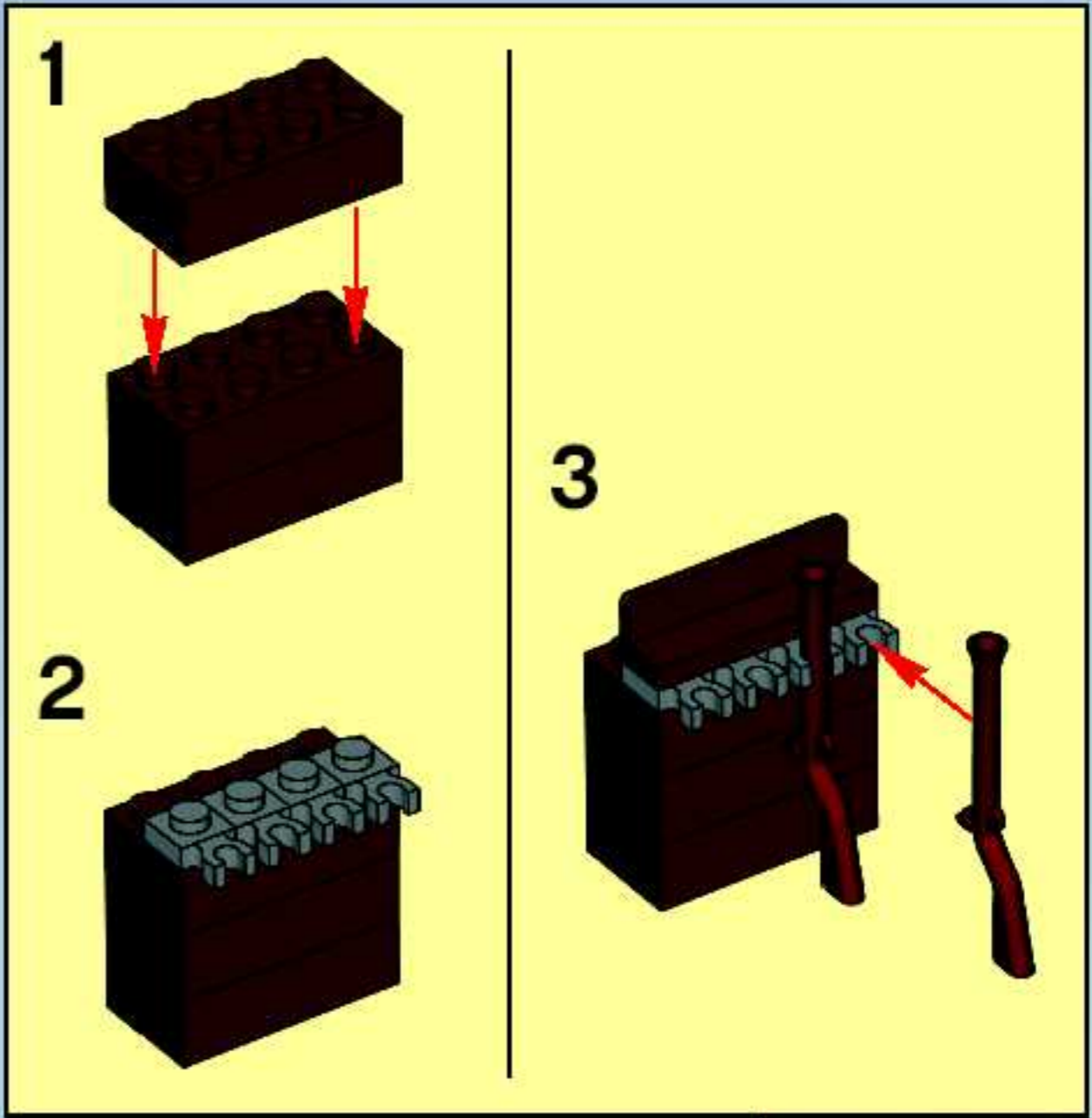

13



14

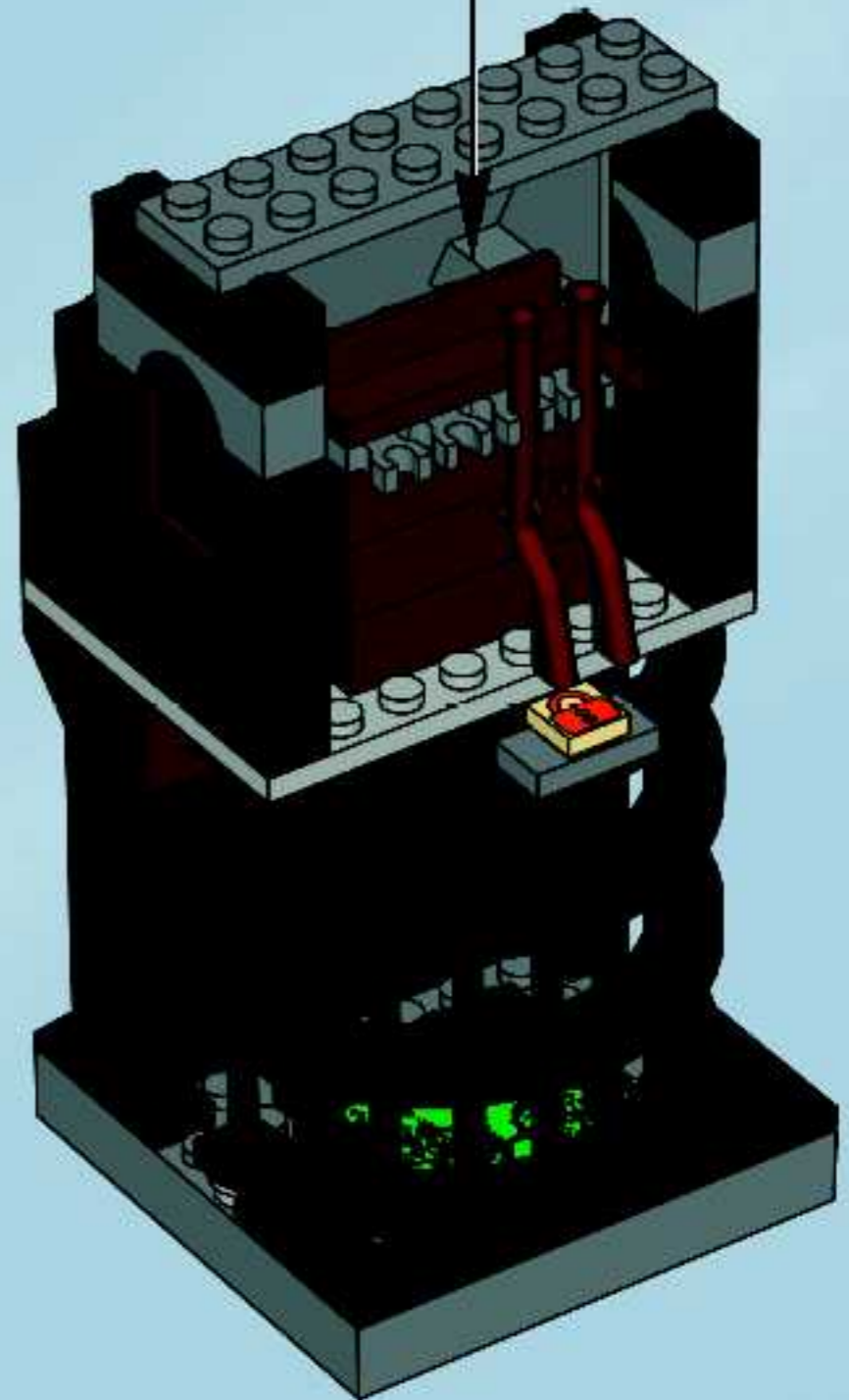

15

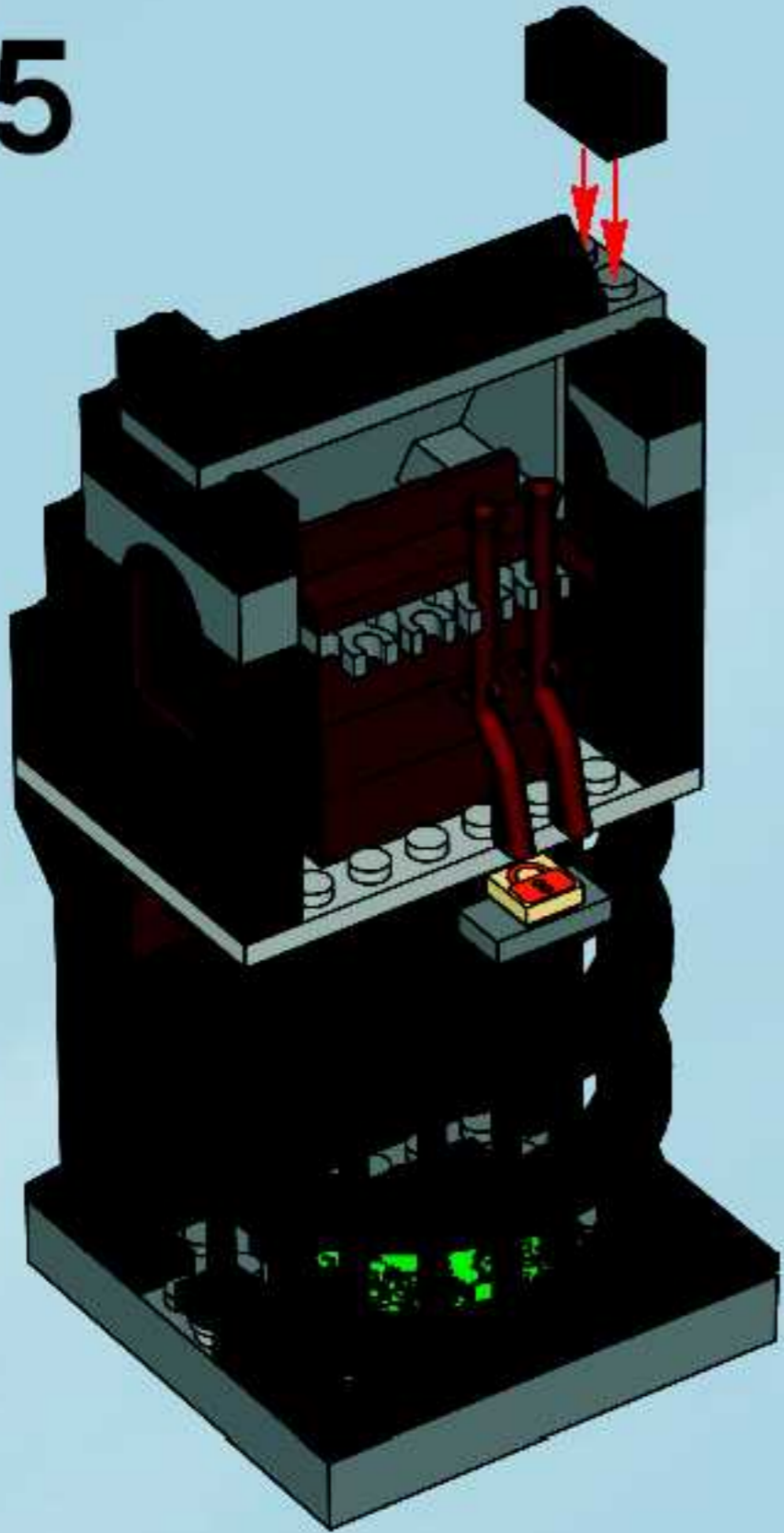

16

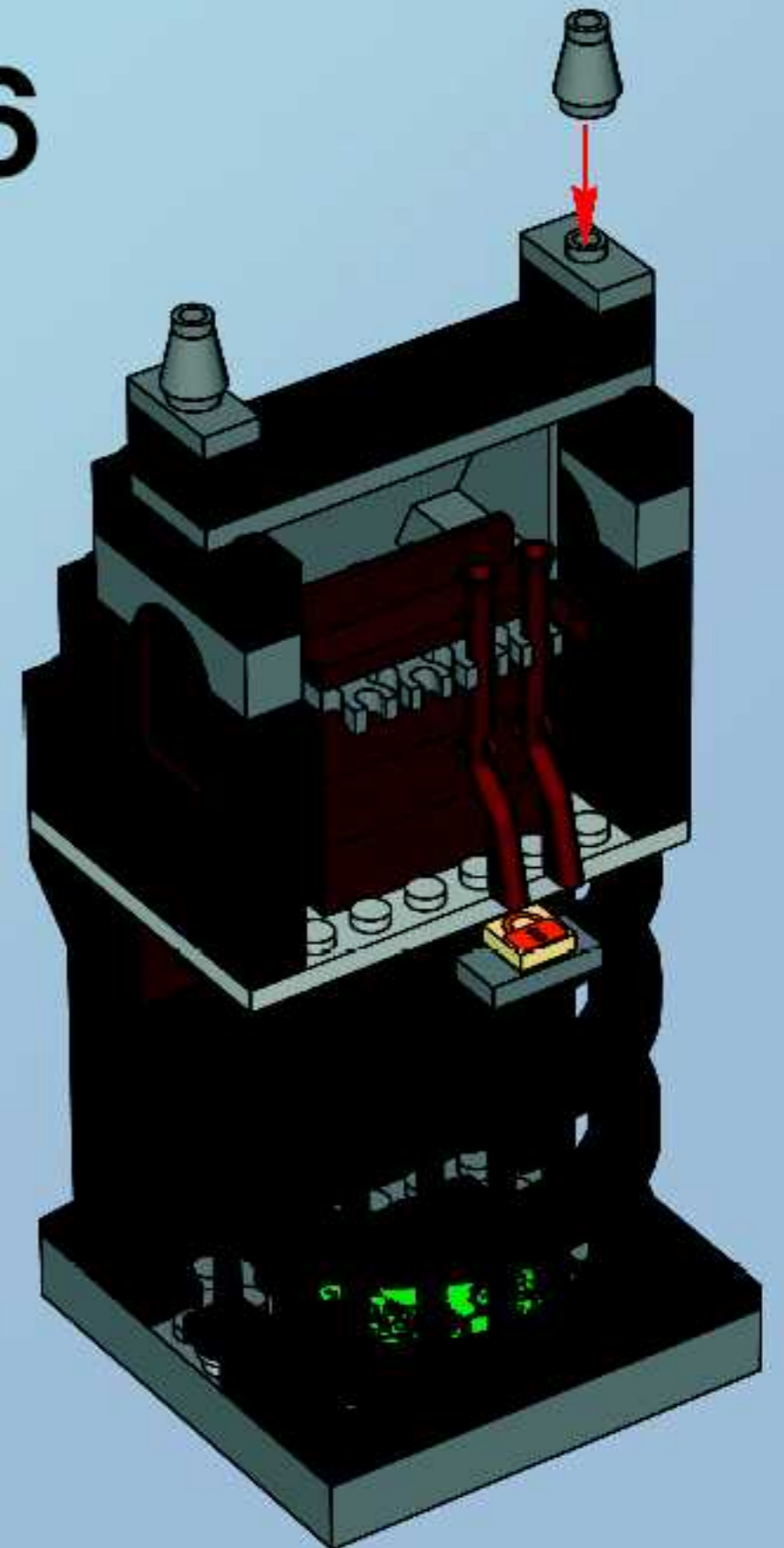

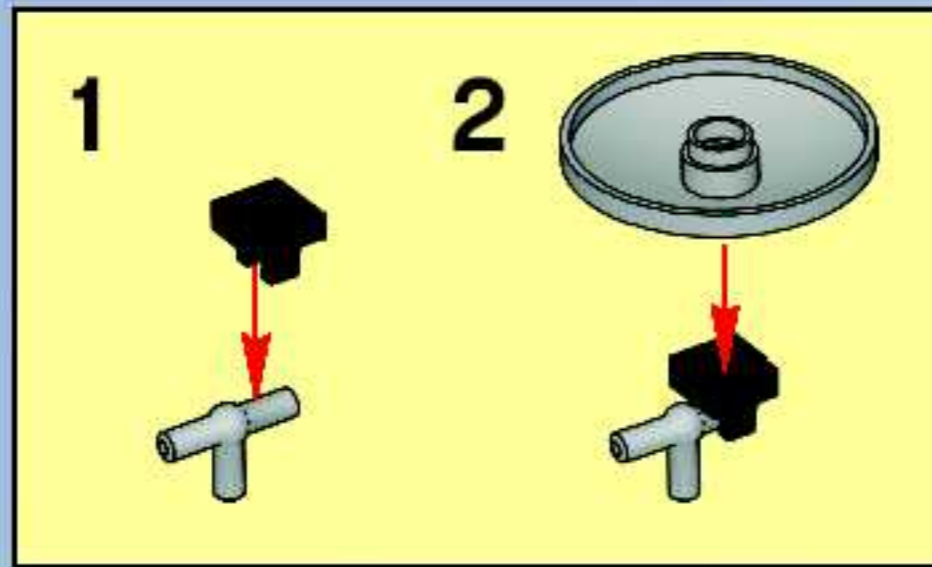

17

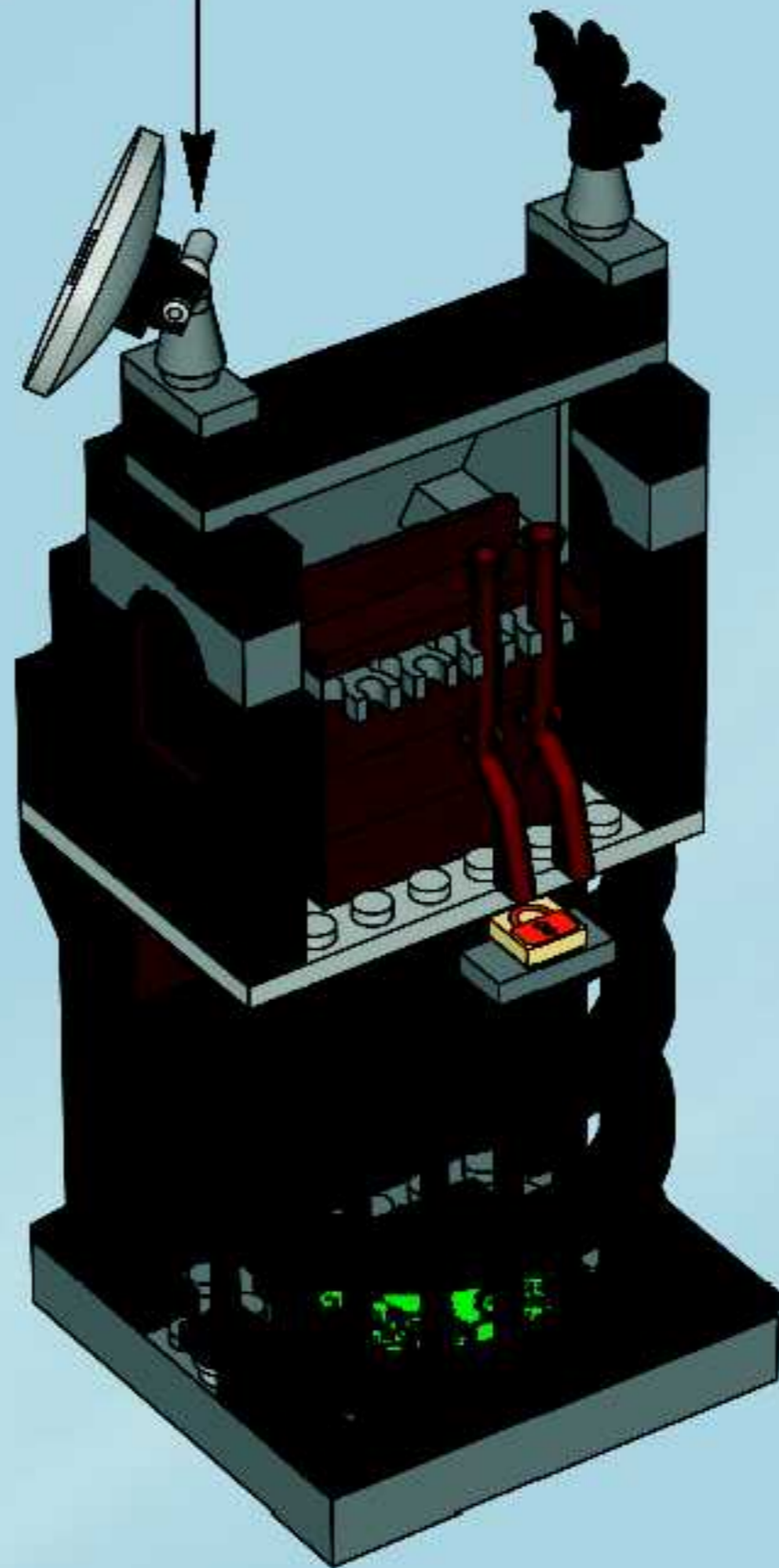

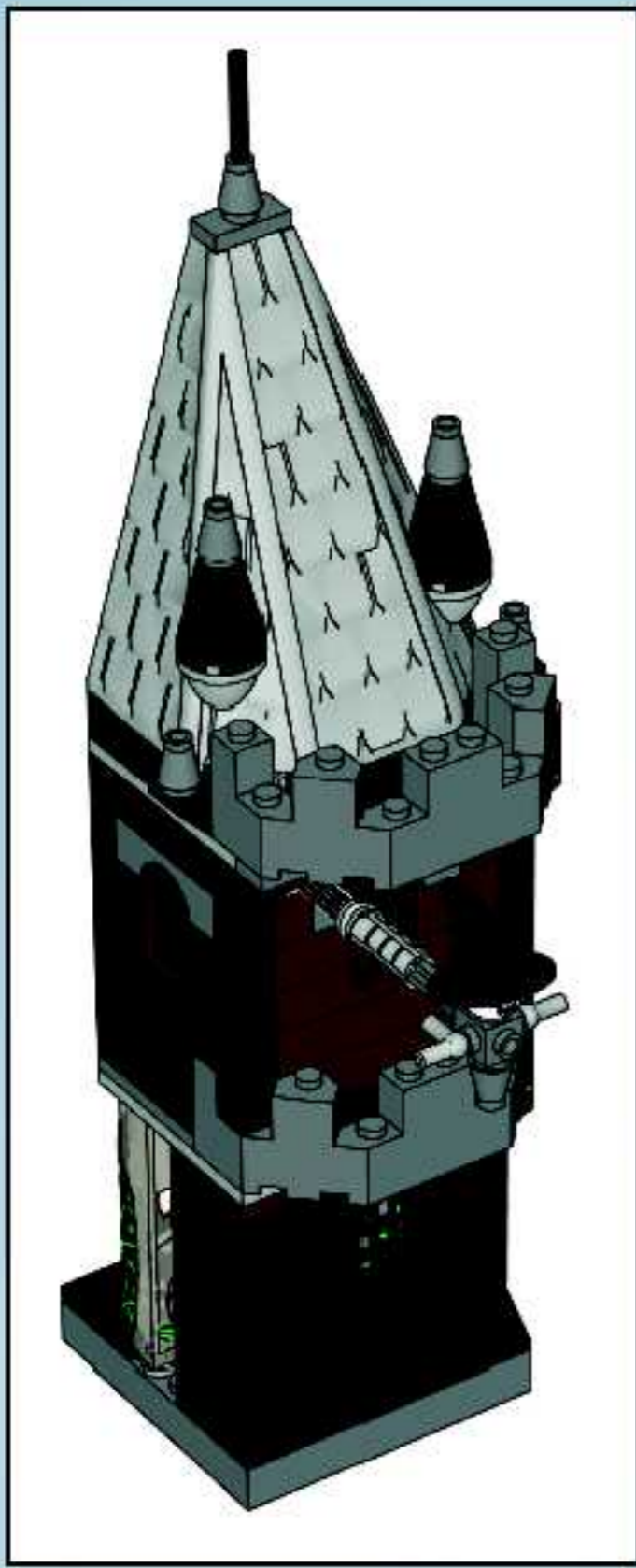

1

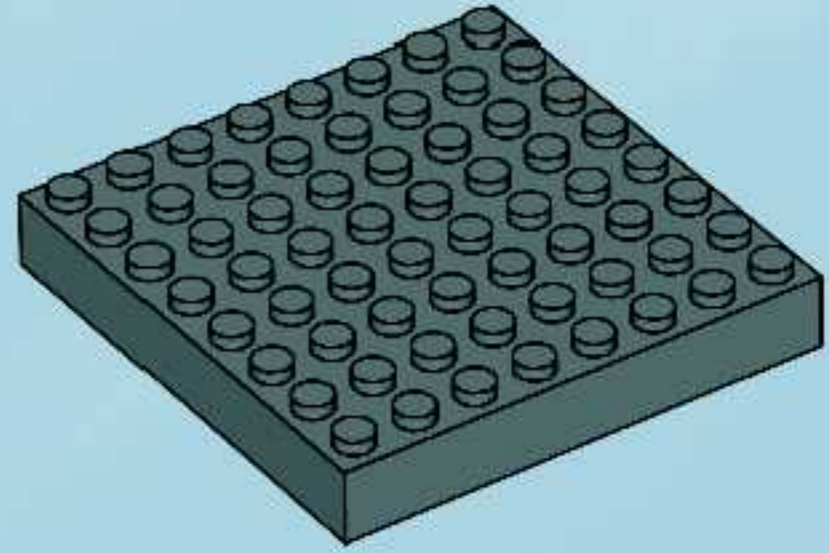

2

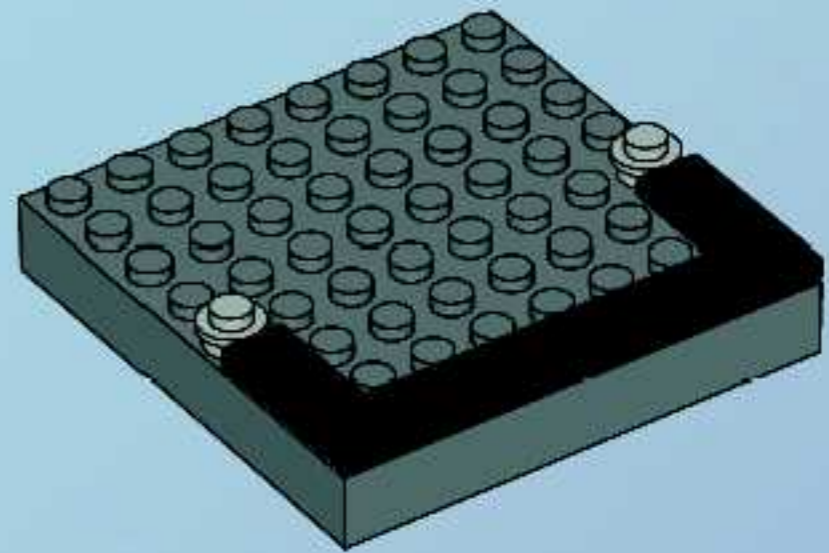

3

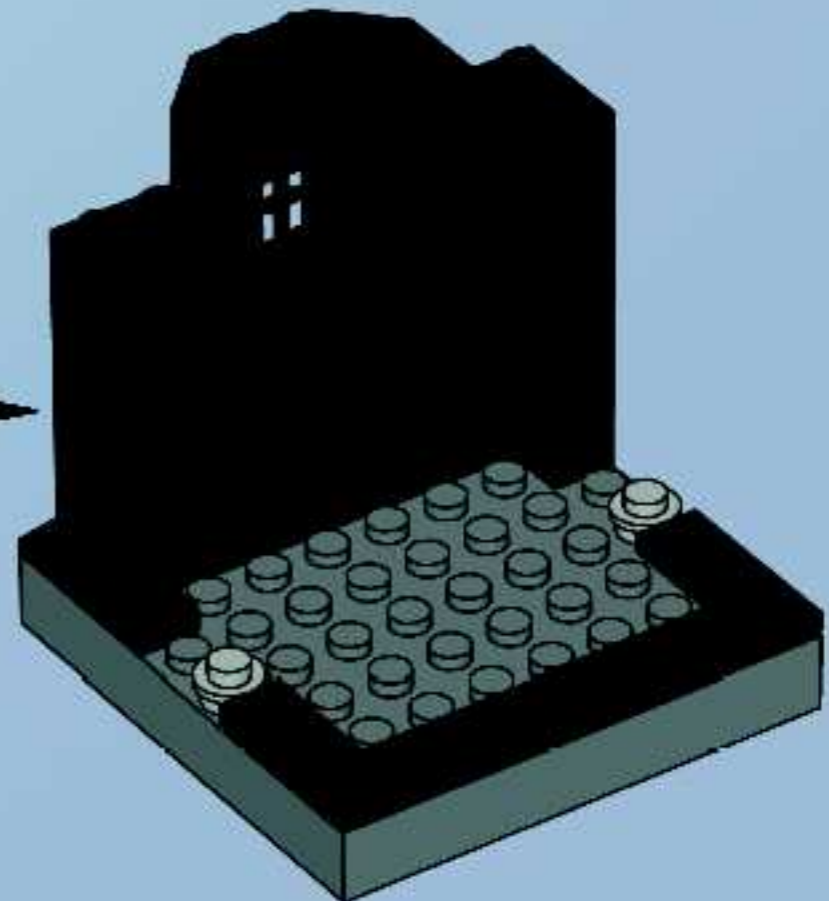
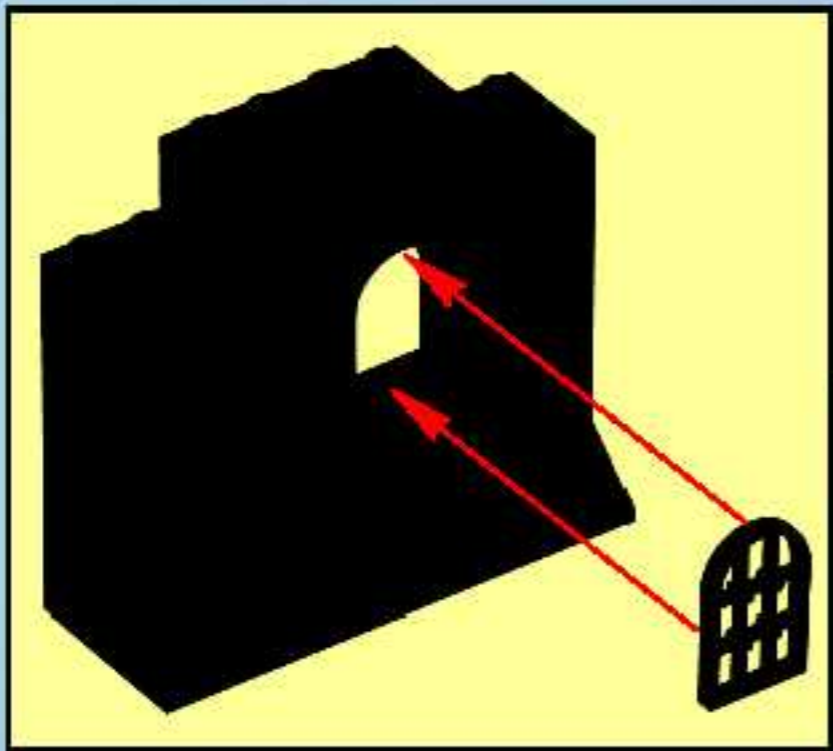

4

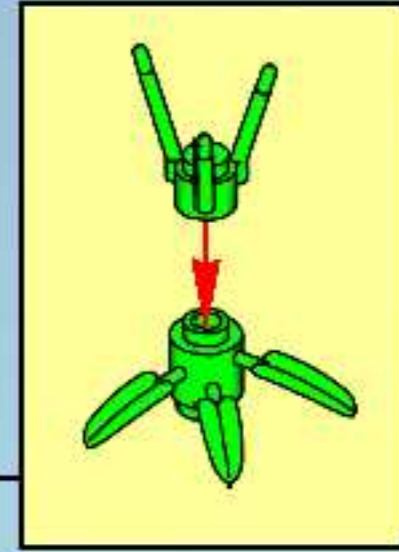
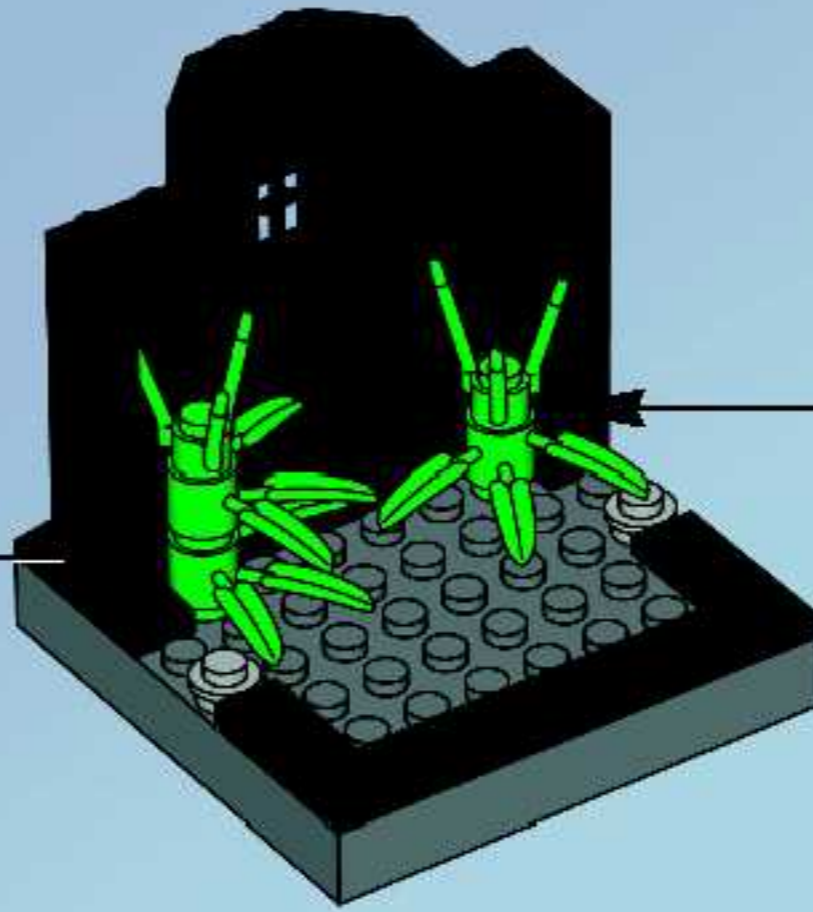
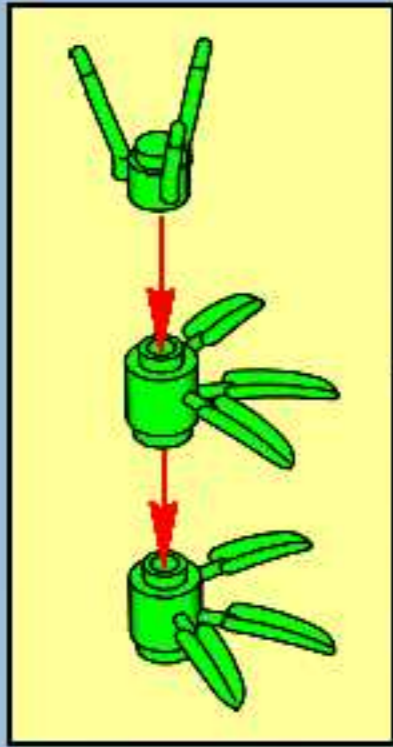

5

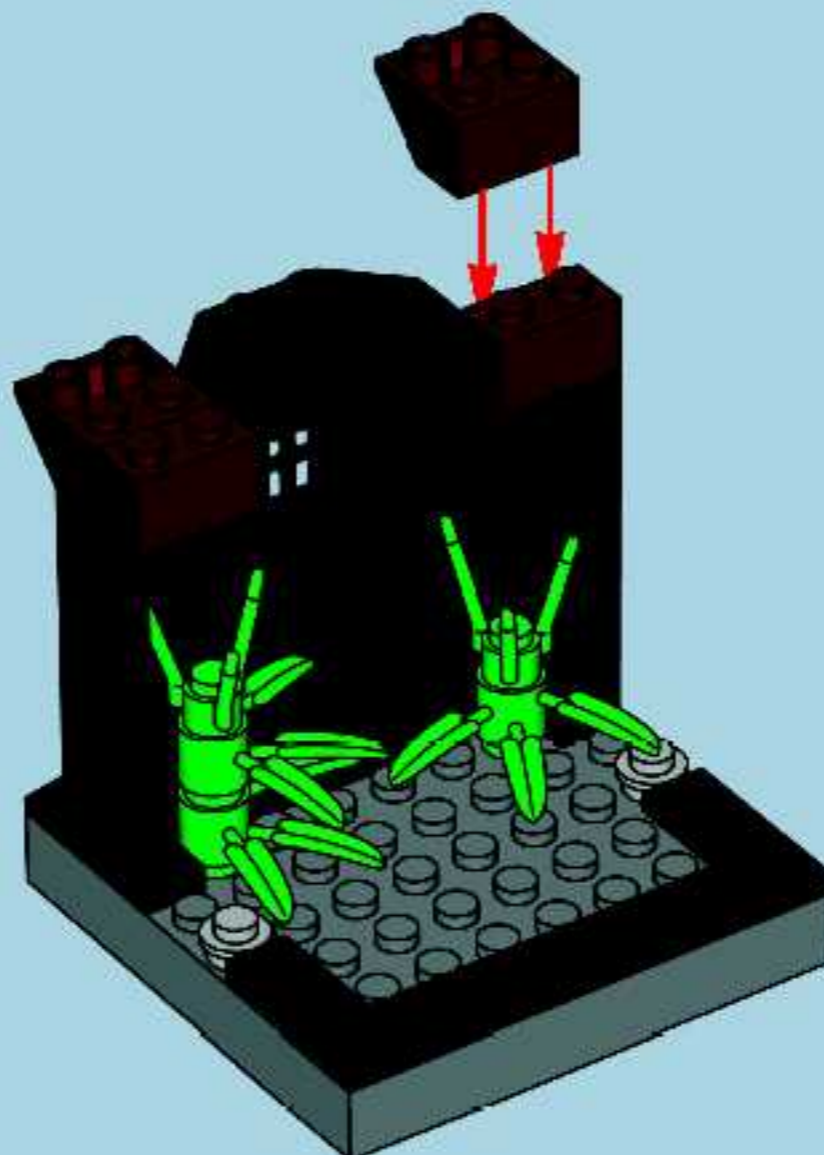

6

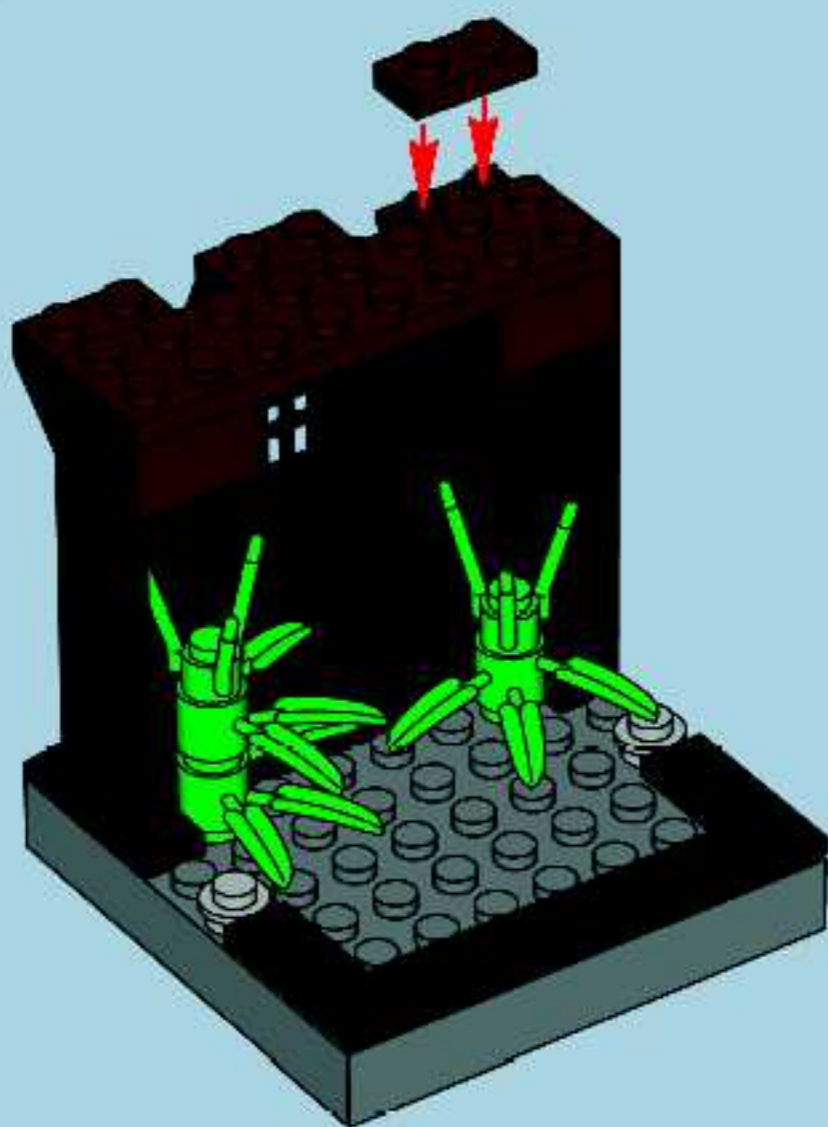

8

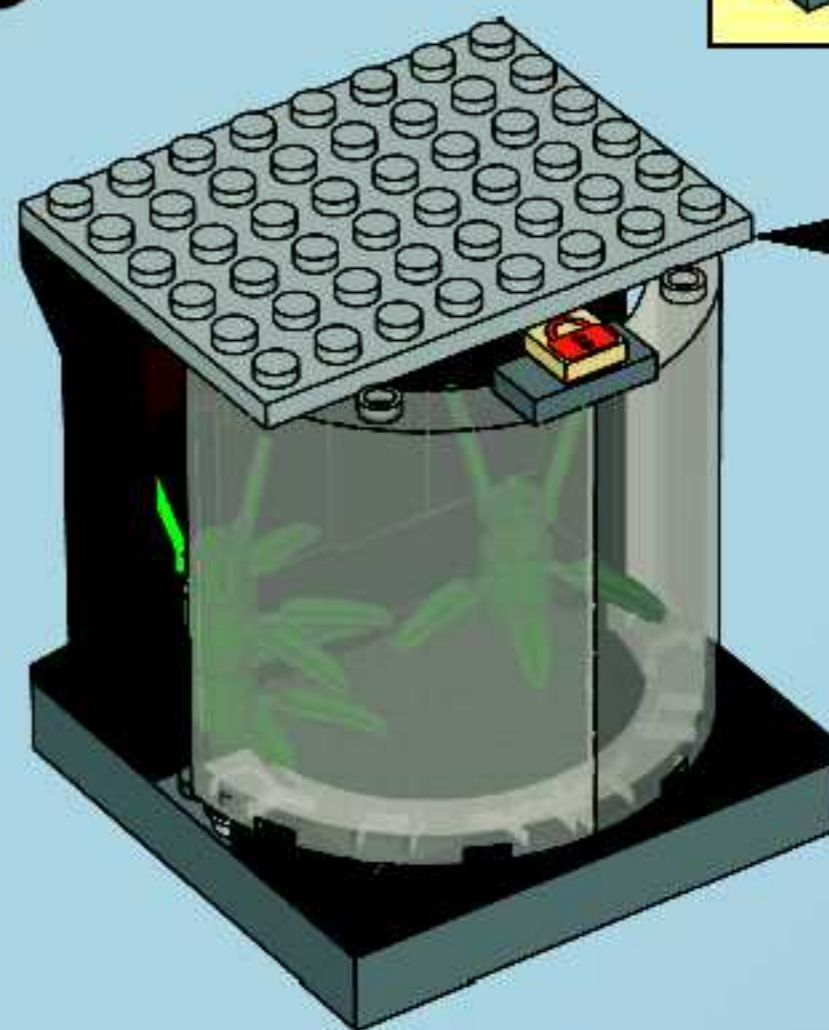

7

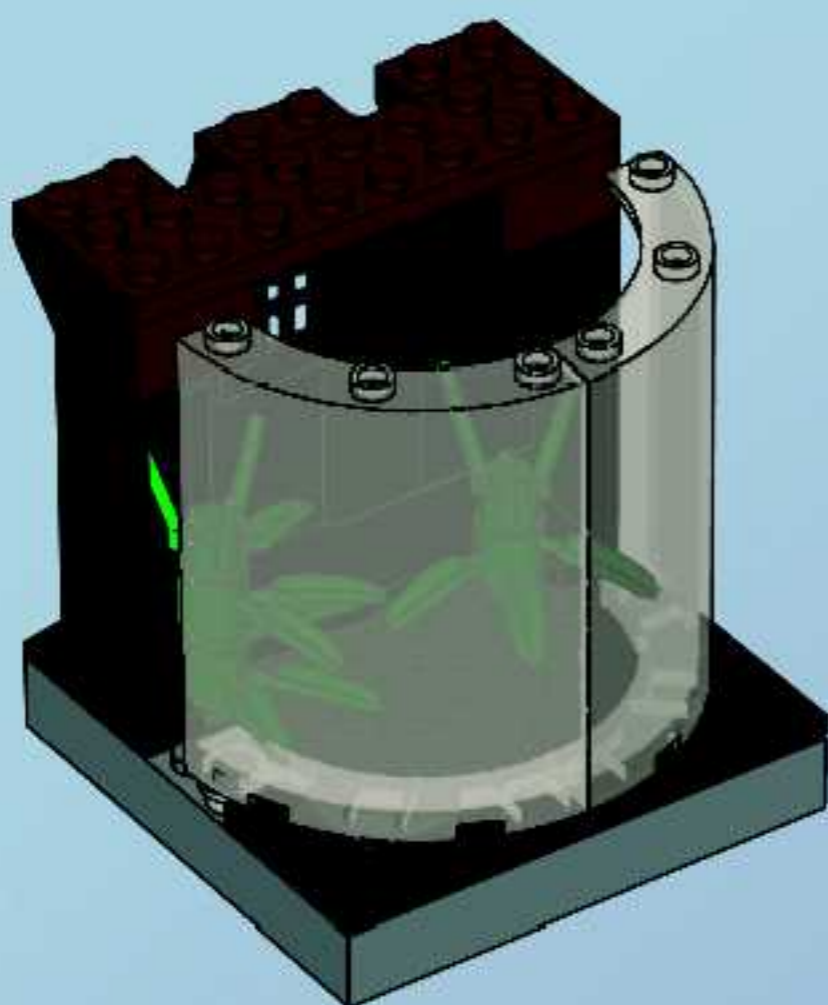

9



10



11



12



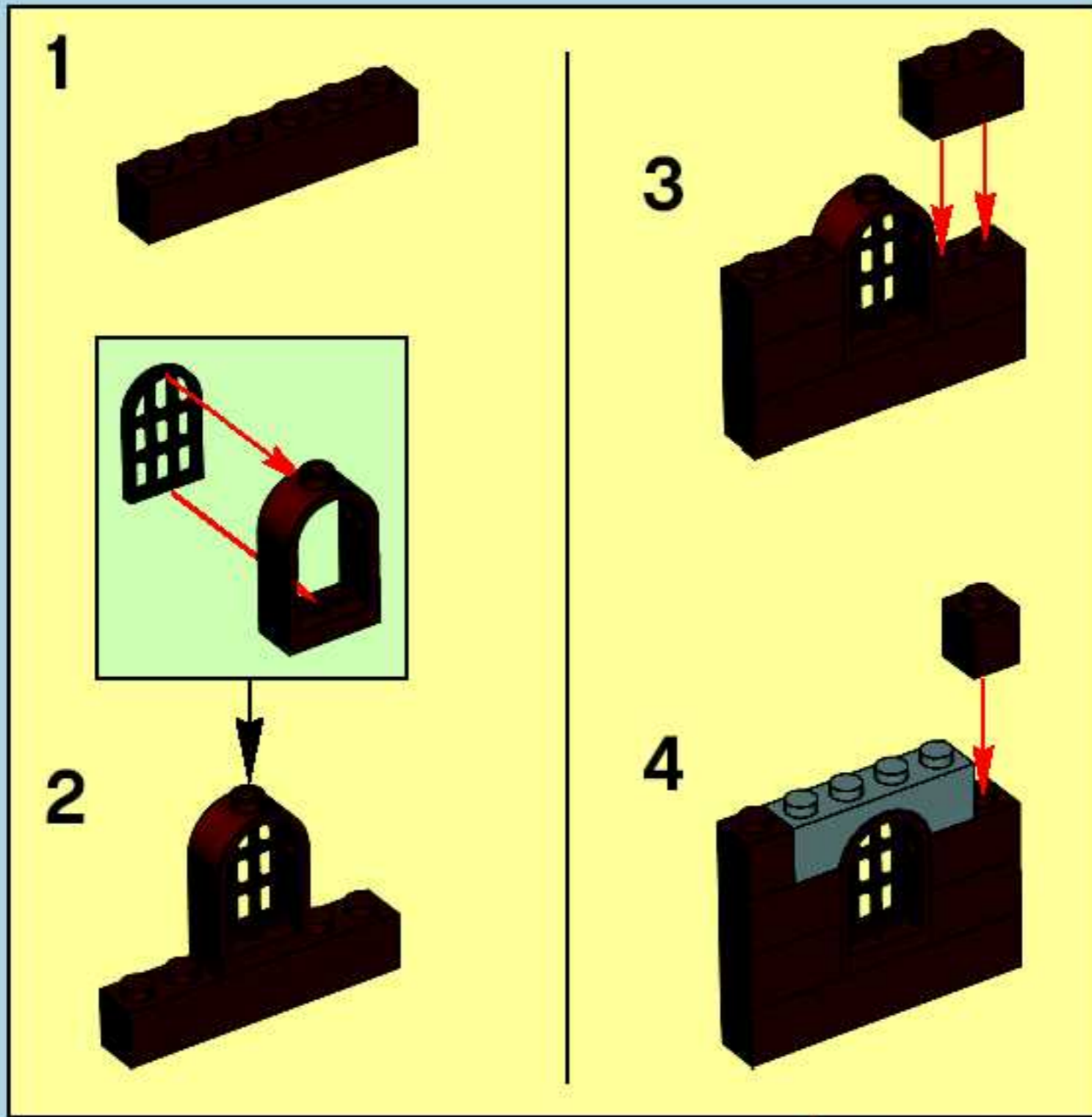

13

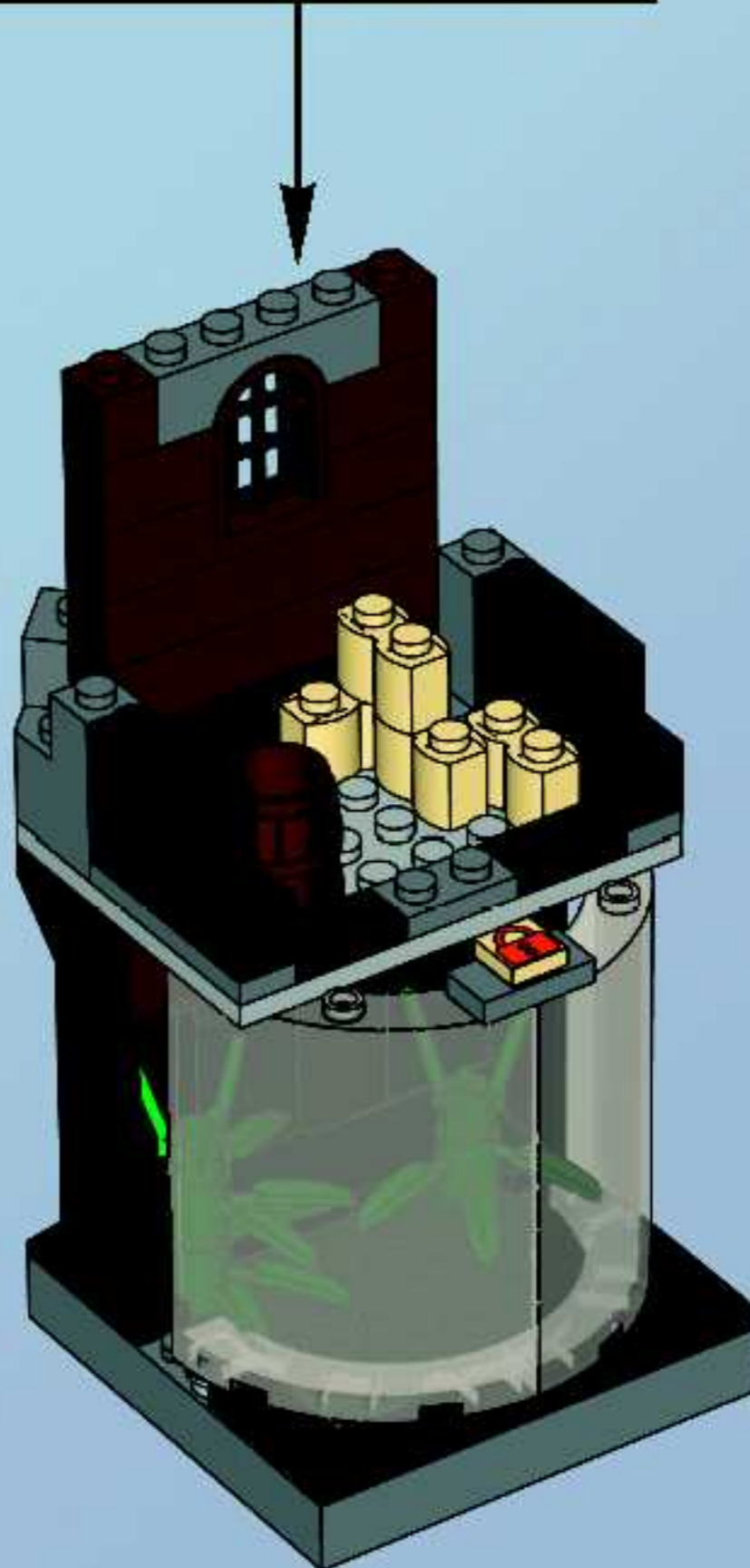

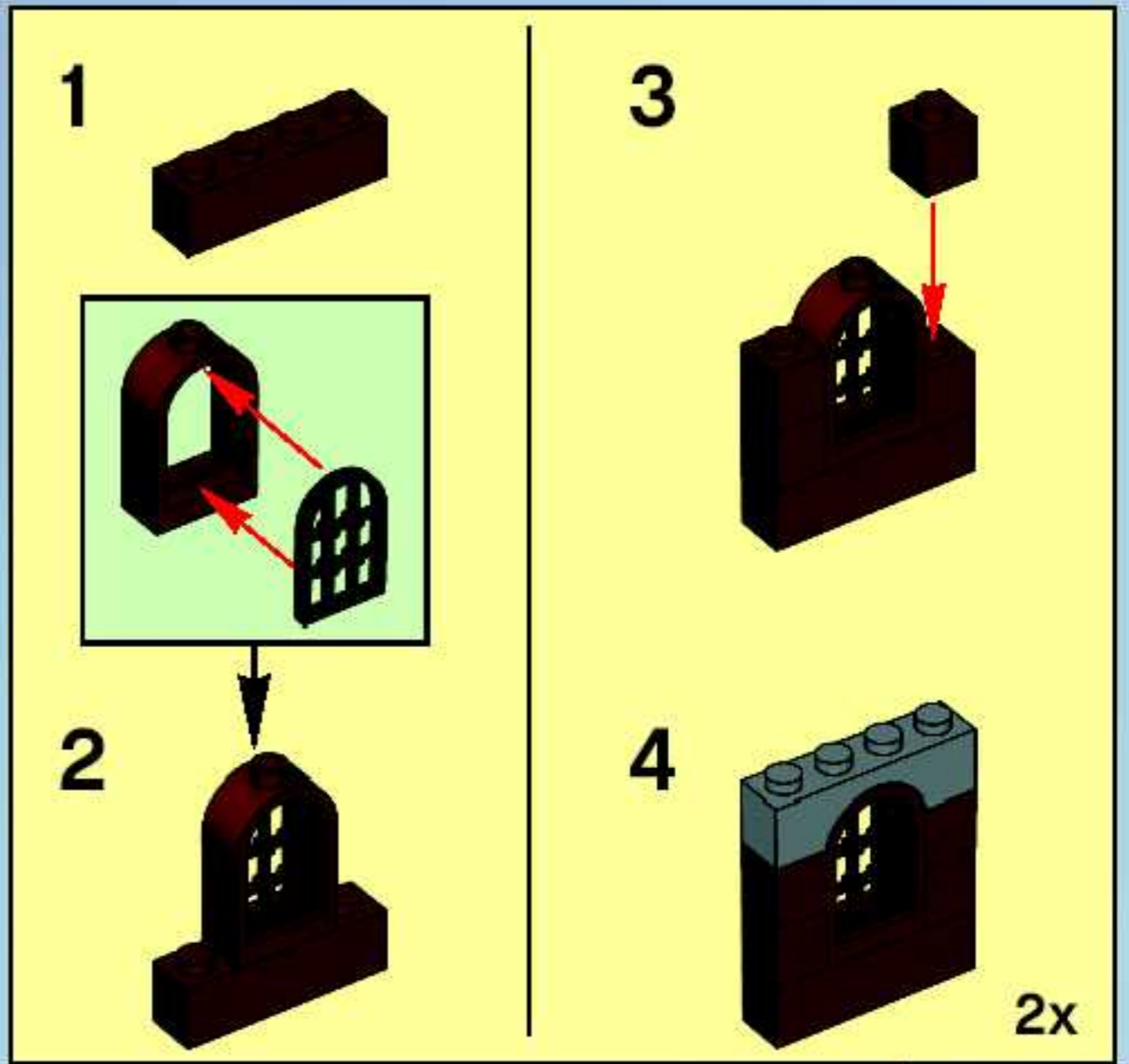

14



15



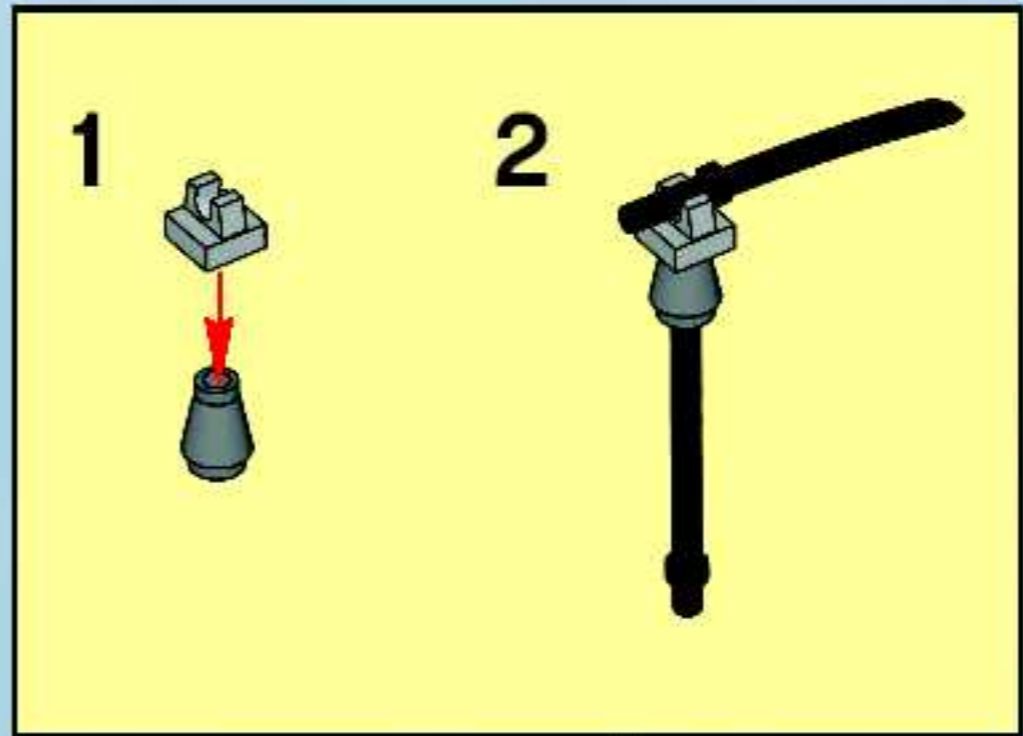

16

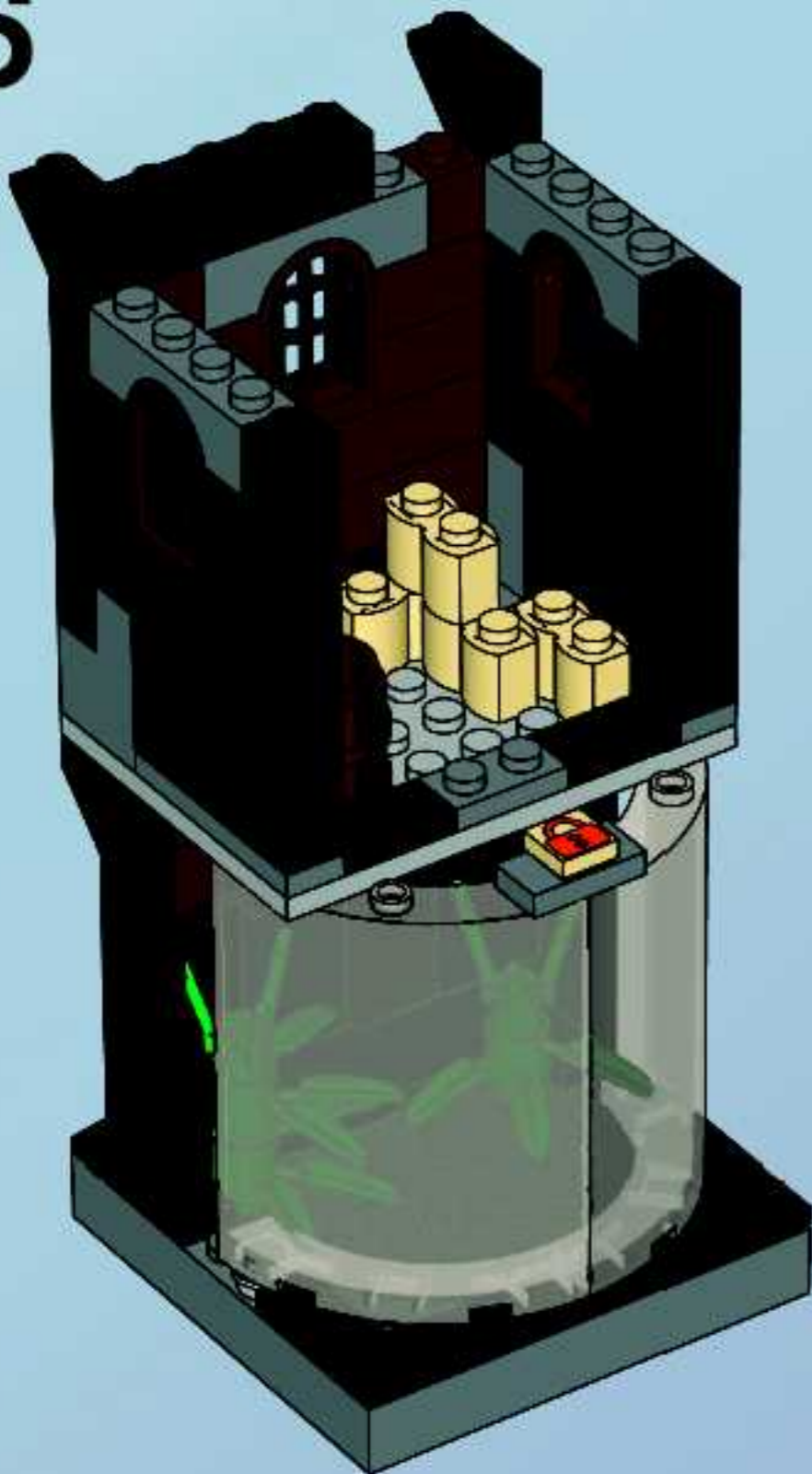

17

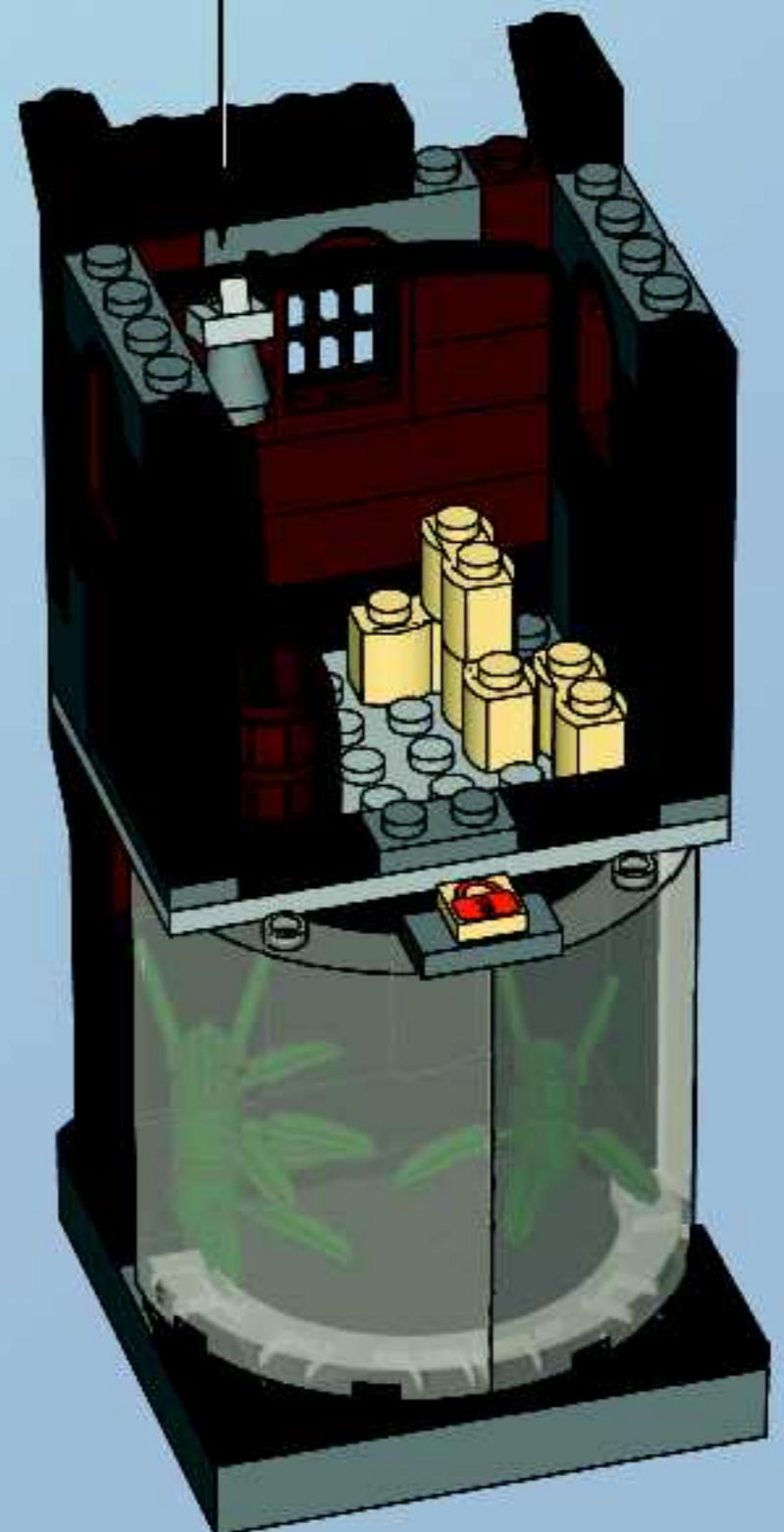

18

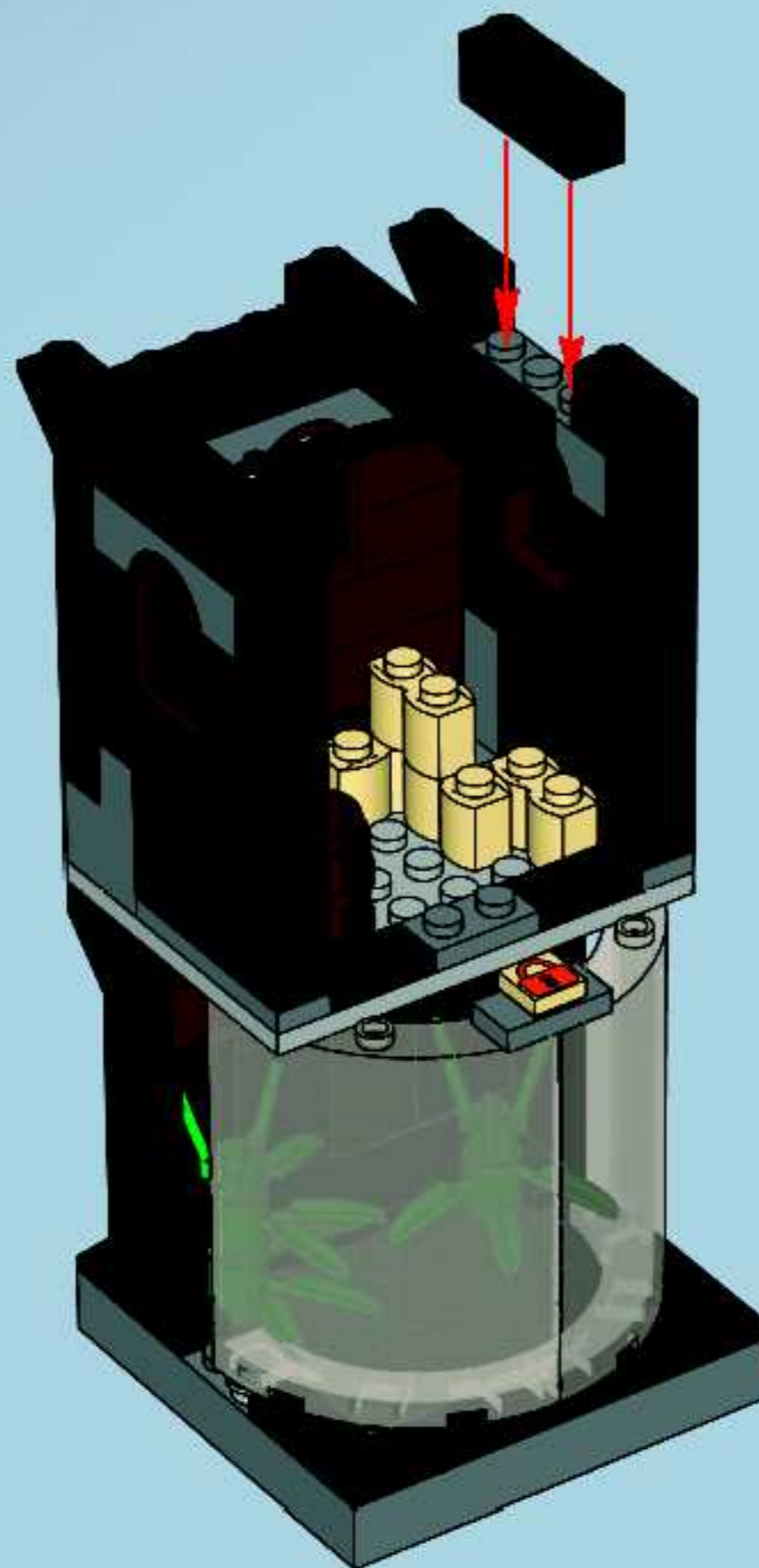

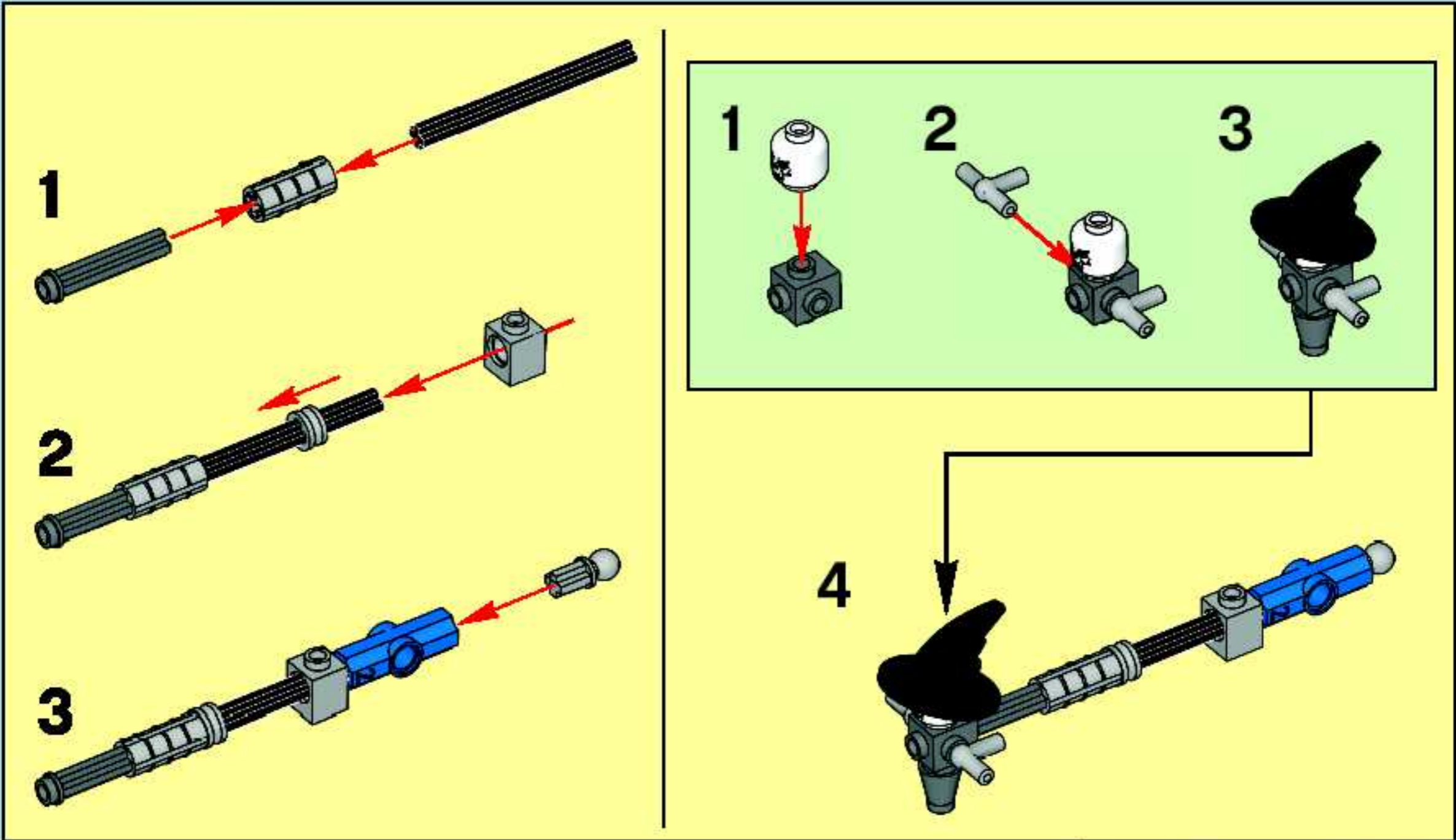

19

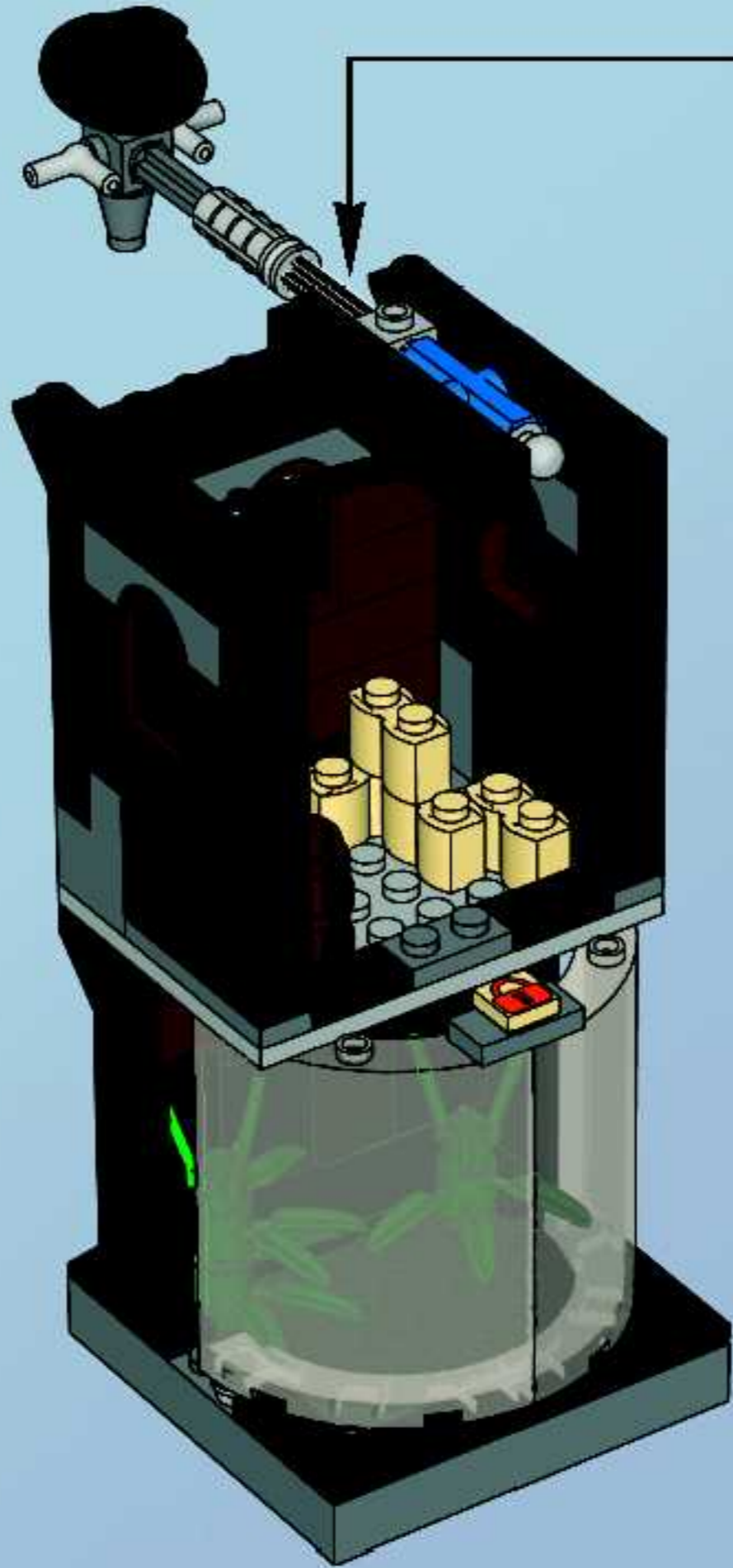

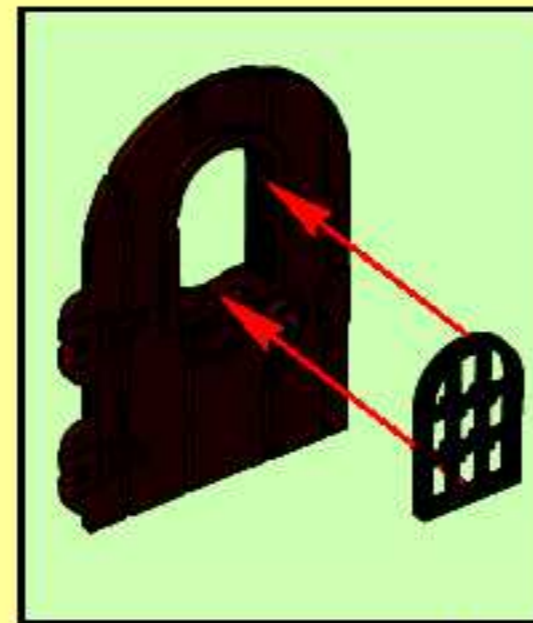
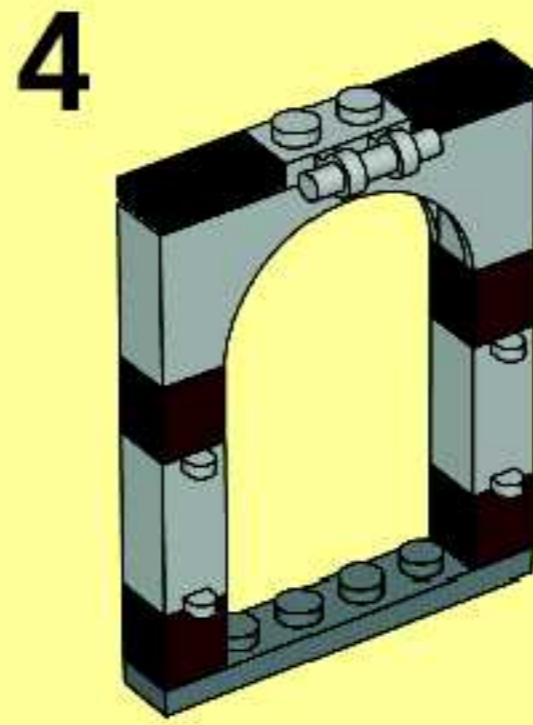
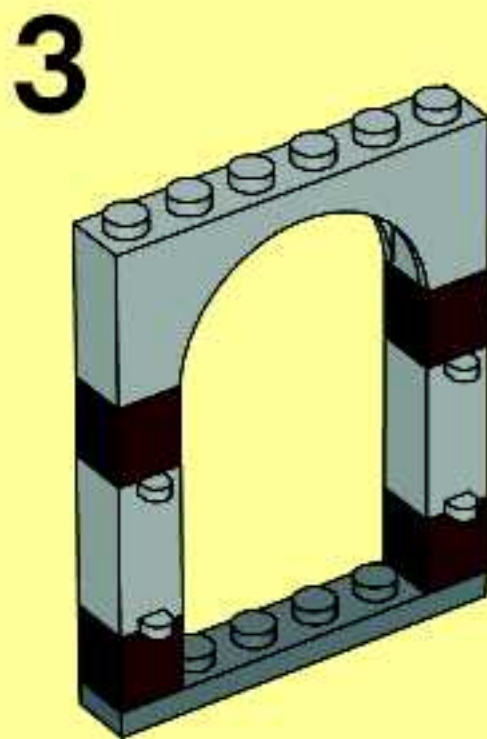
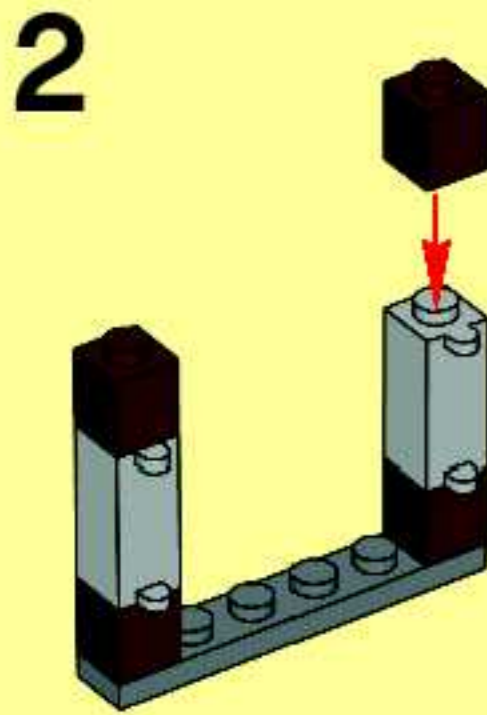
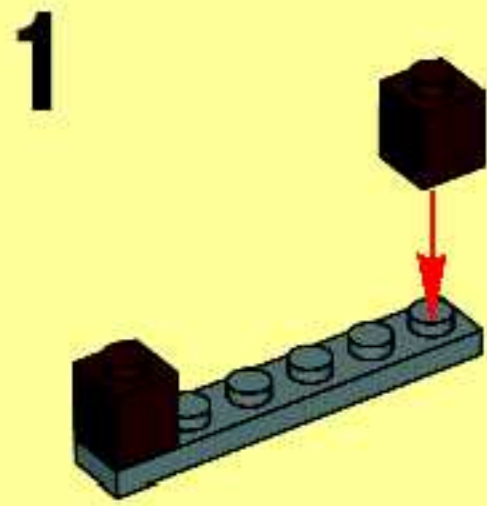

20

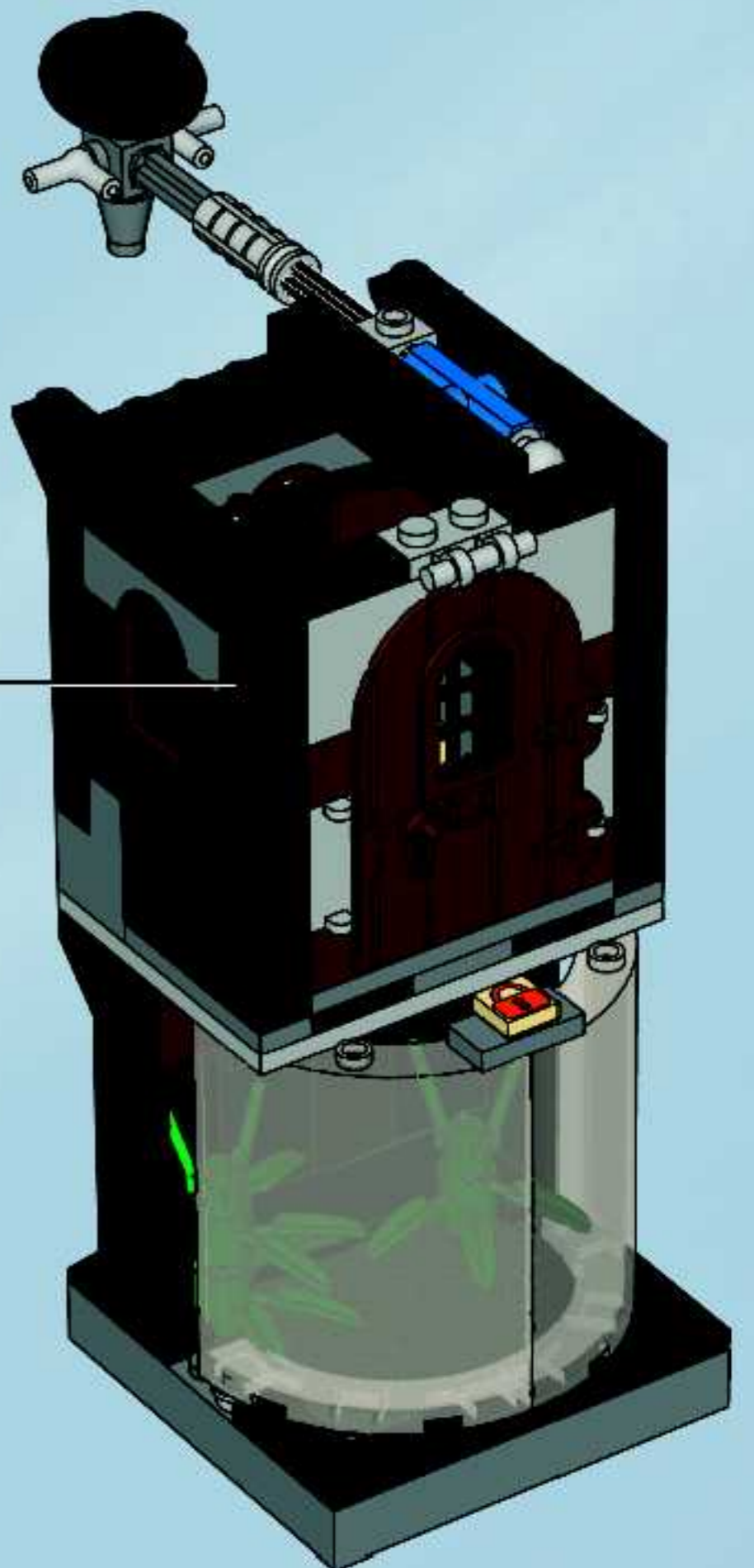

21



22

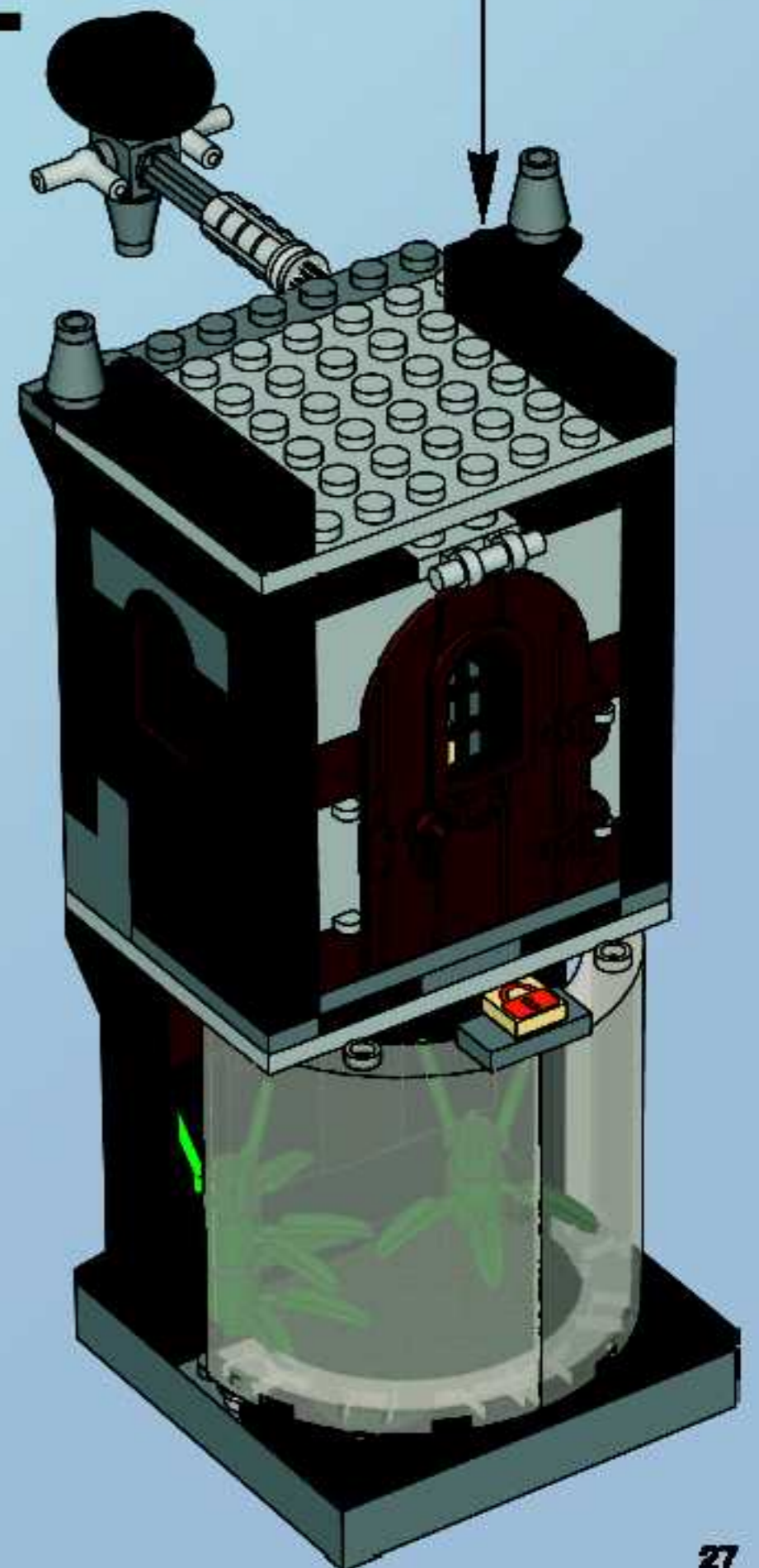
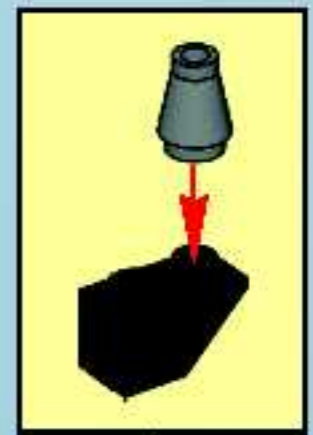

23



24



25

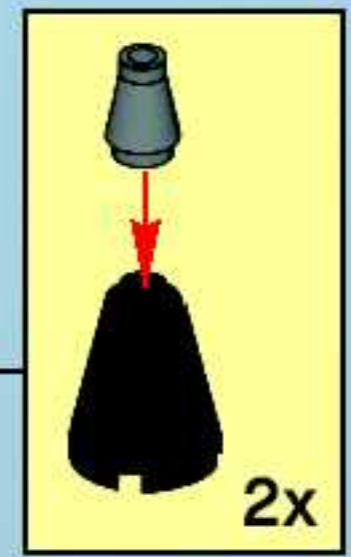
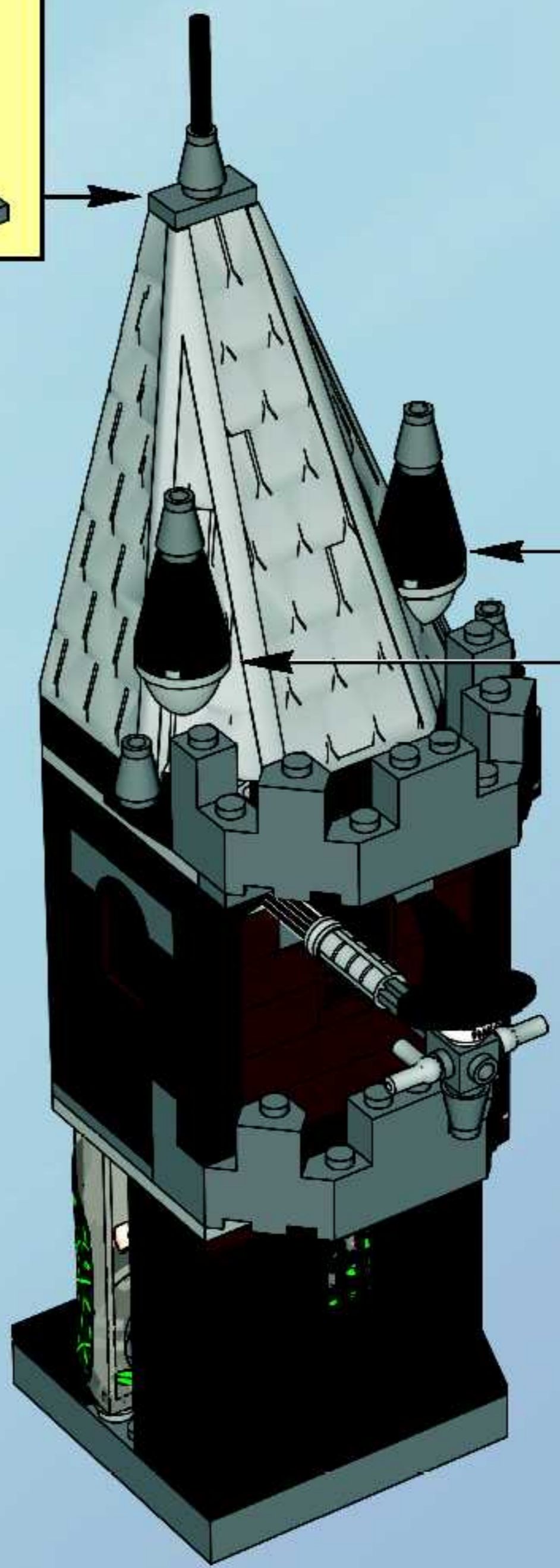
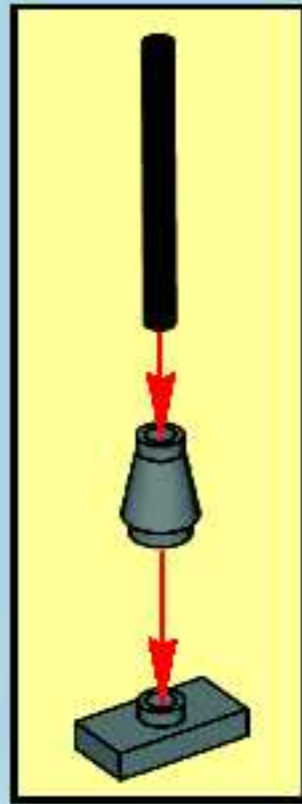















7782

7780

7779

7781

7780



7783

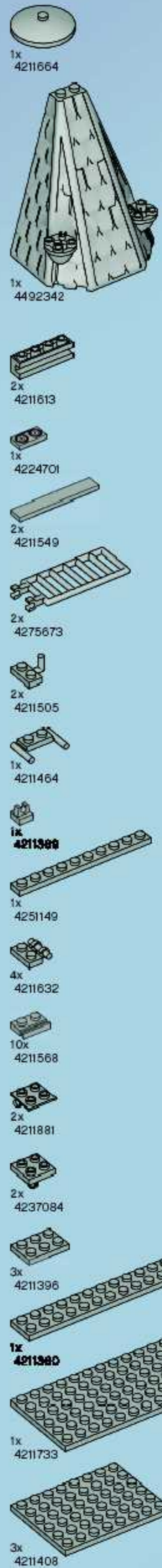
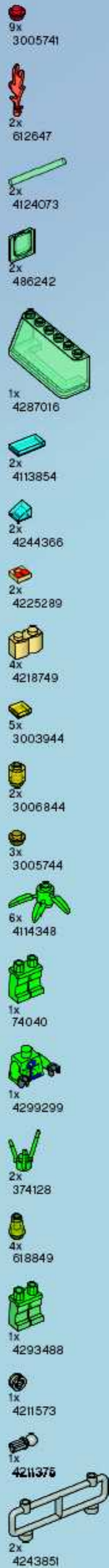
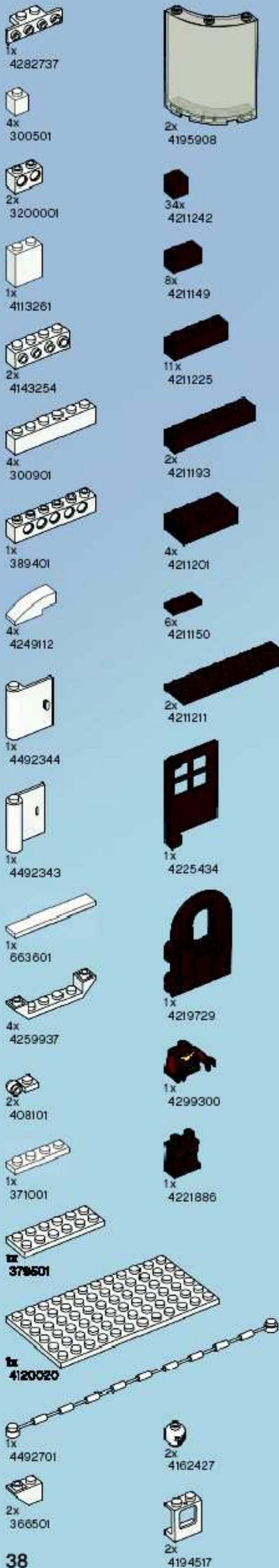



LEGO and the LEGO logo are trademarks of the LEGO Group. ©2006 The LEGO Group. 4499508

BATMAN and all related characters and elements are trademarks of and © DC Comics. TM & © Warner Bros. Entertainment Inc. (2006)



7784