



60004

CITY



67



+

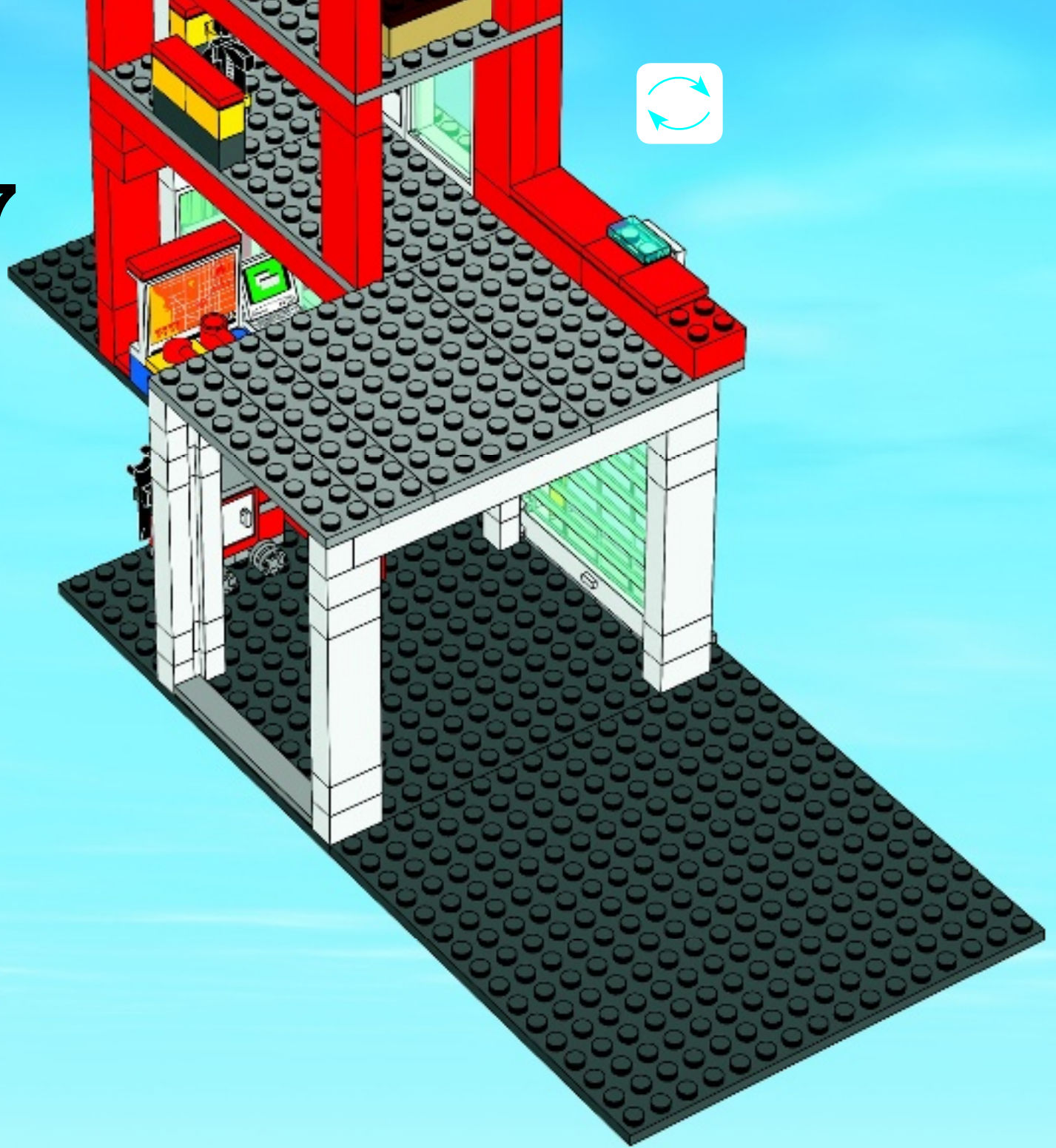

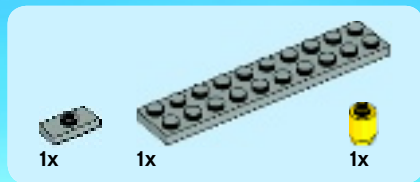

68

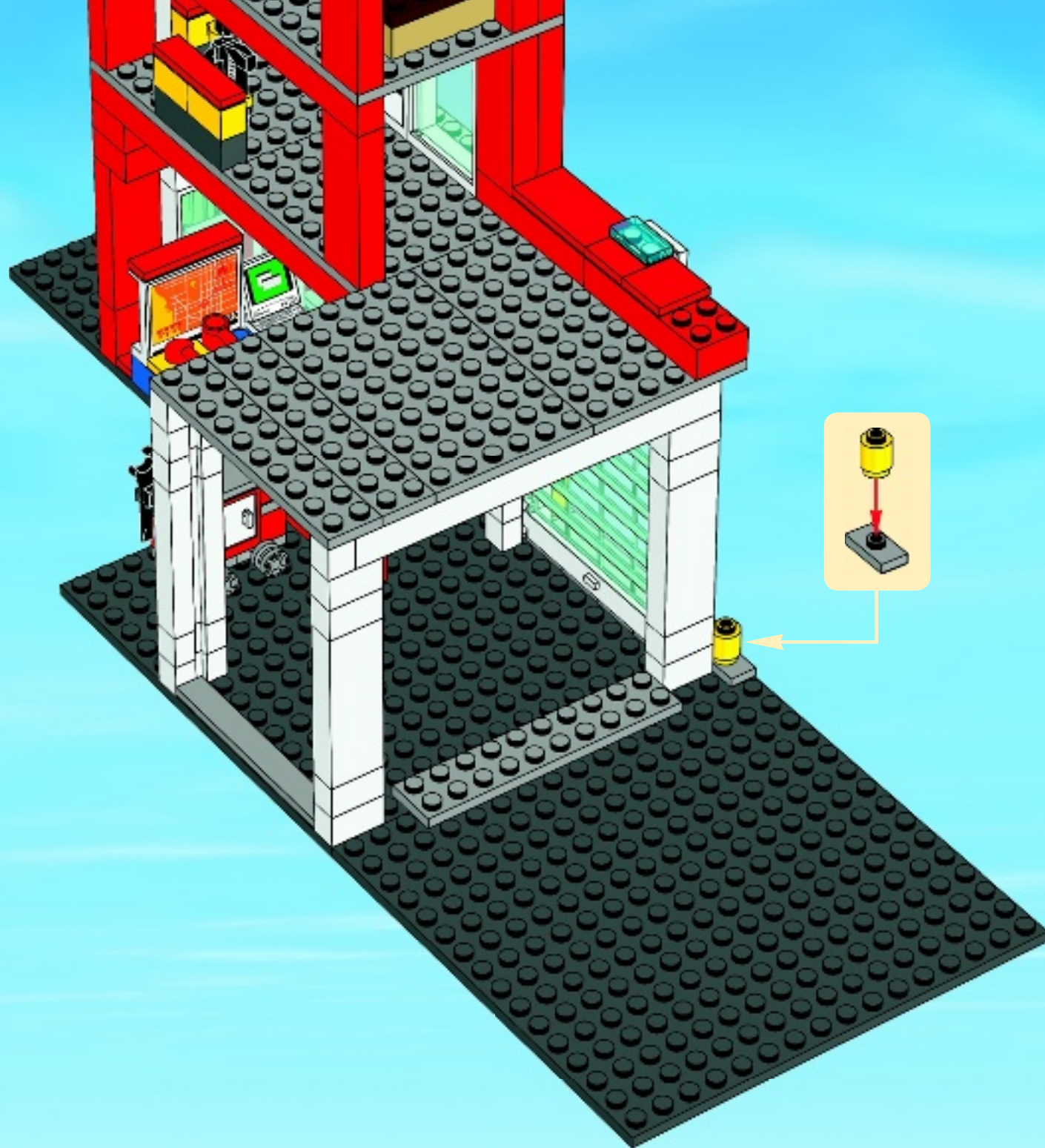

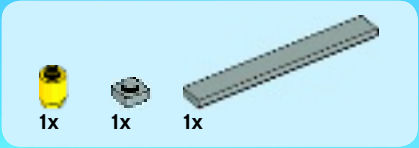

69

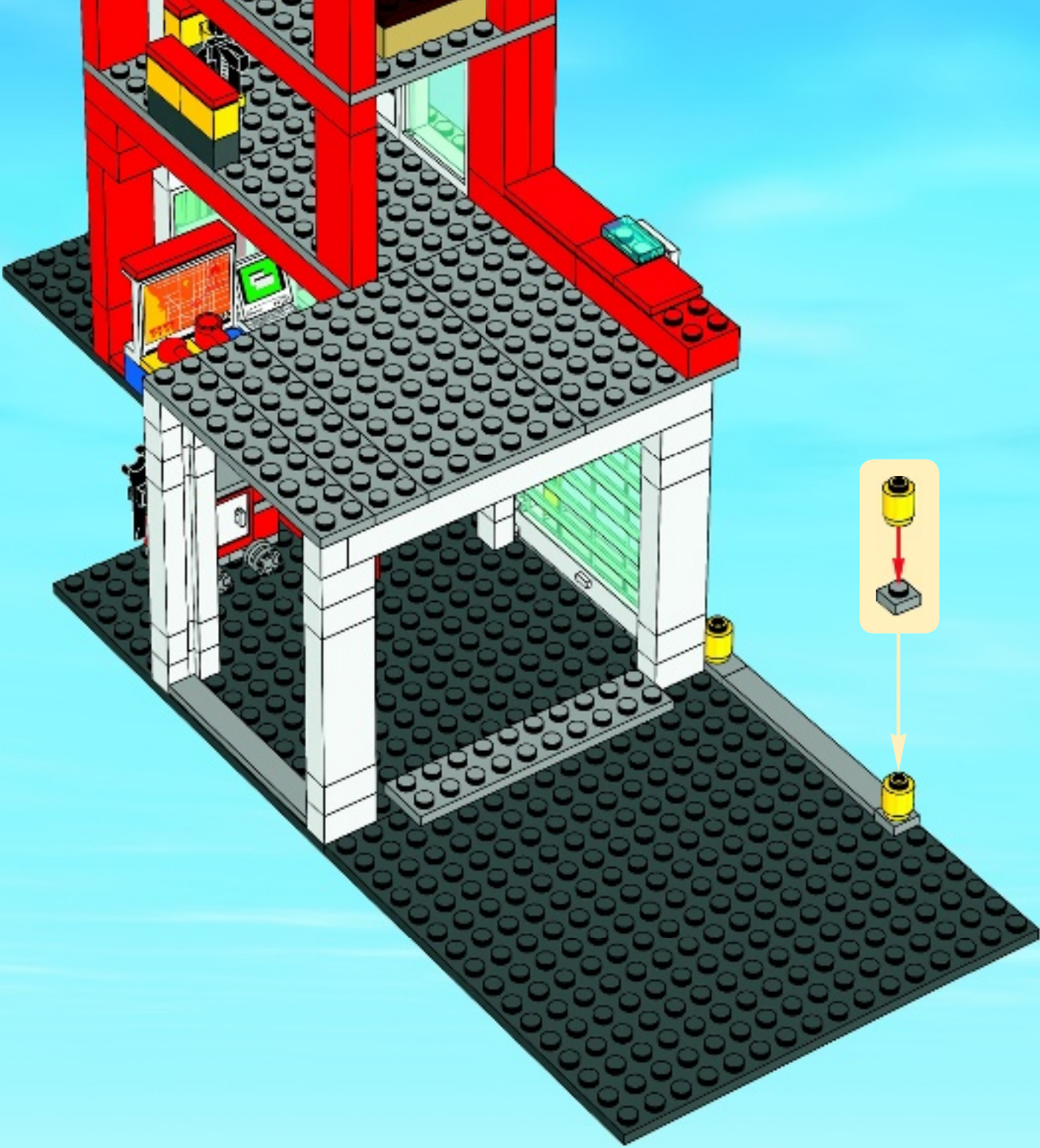



3x

70

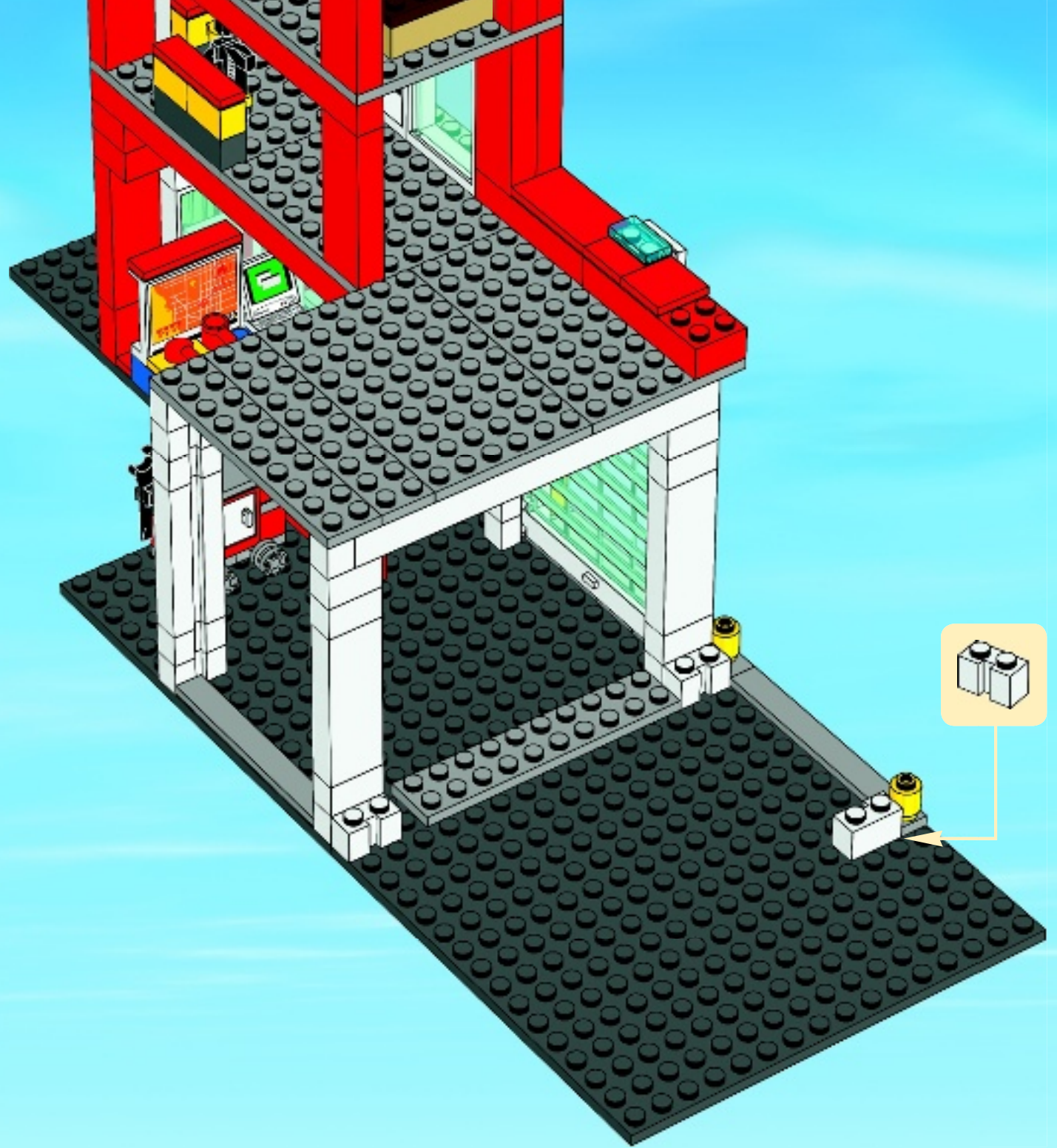



4x

71

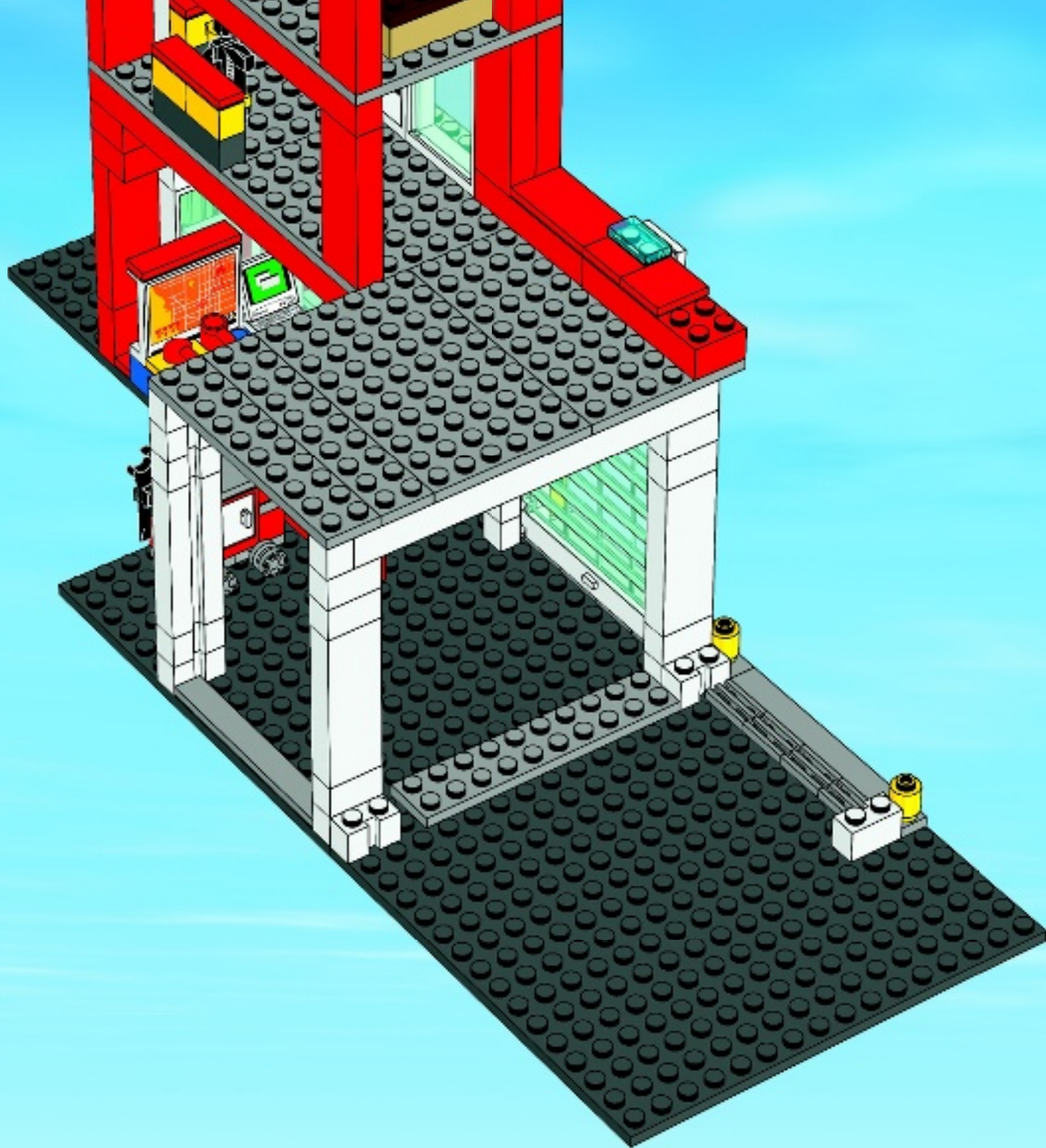

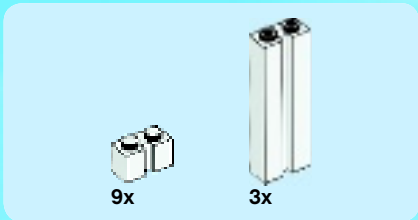
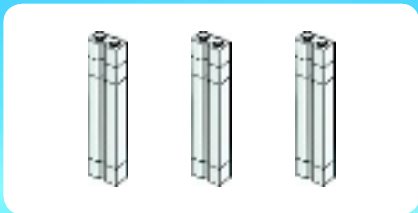

72

1

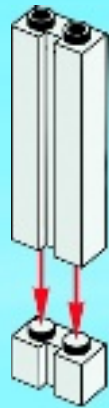

2

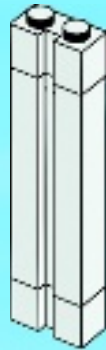

3



3x

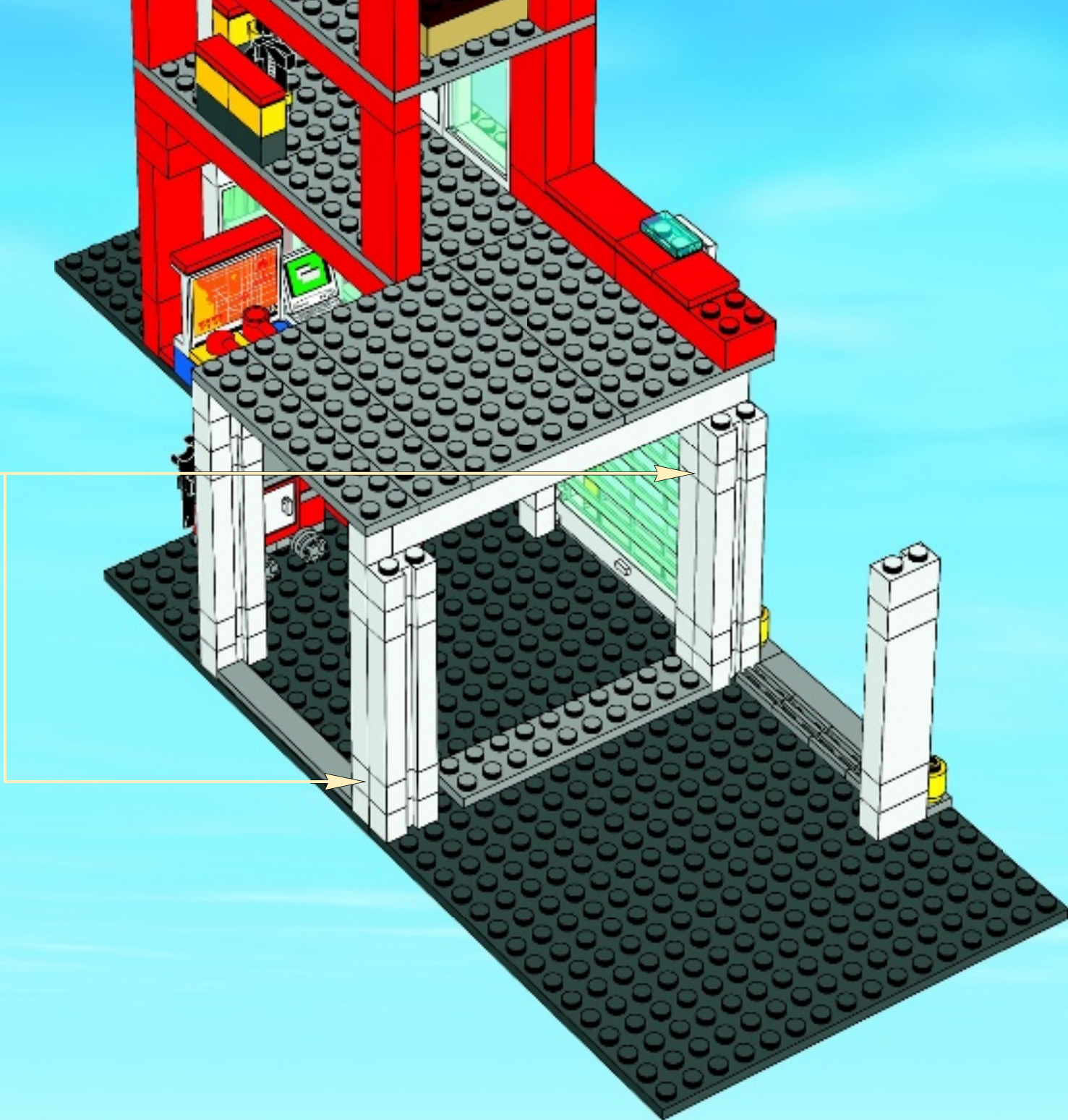

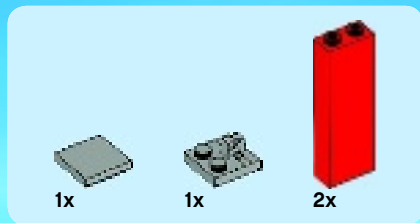

73

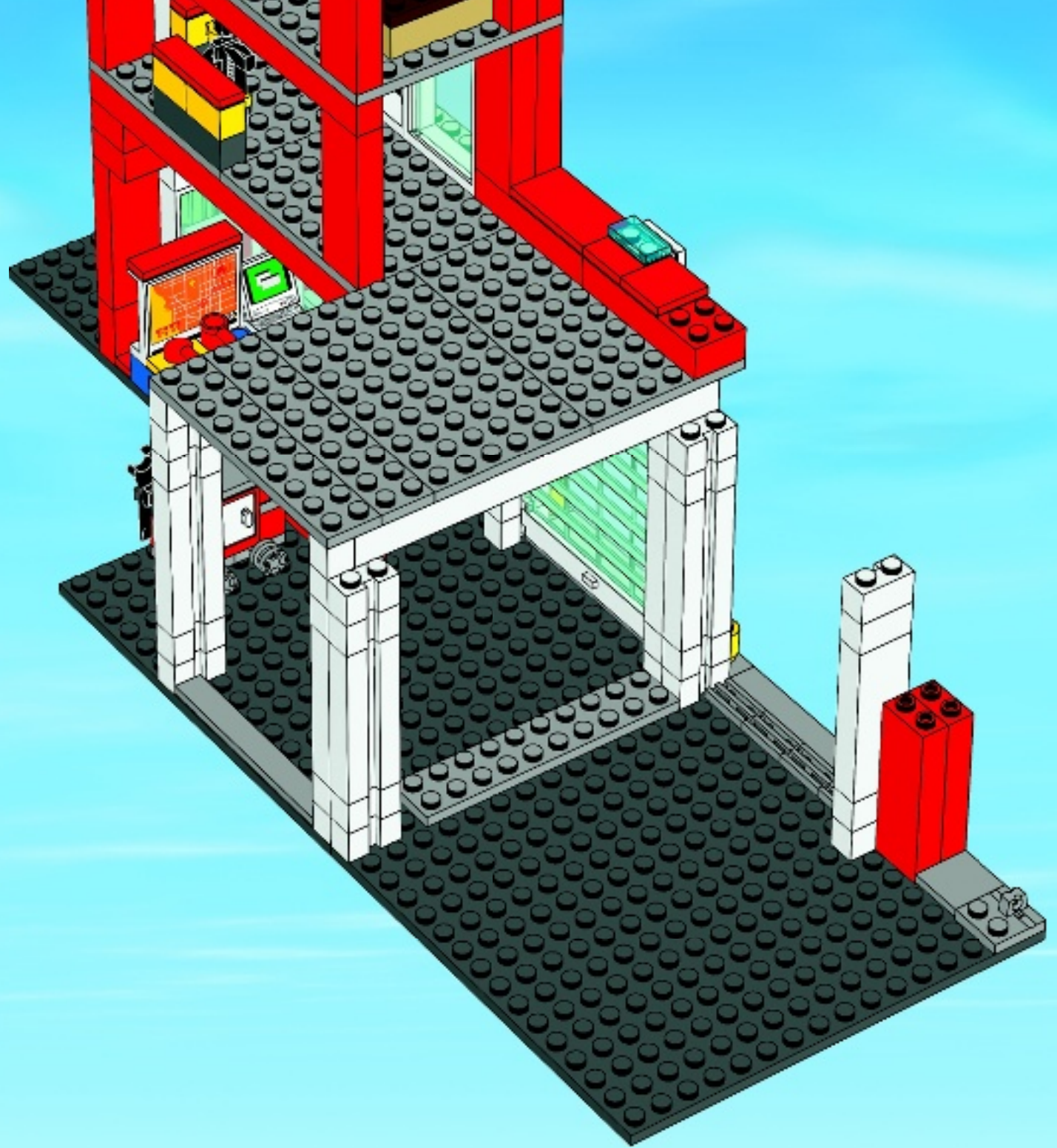



1x



3x

74

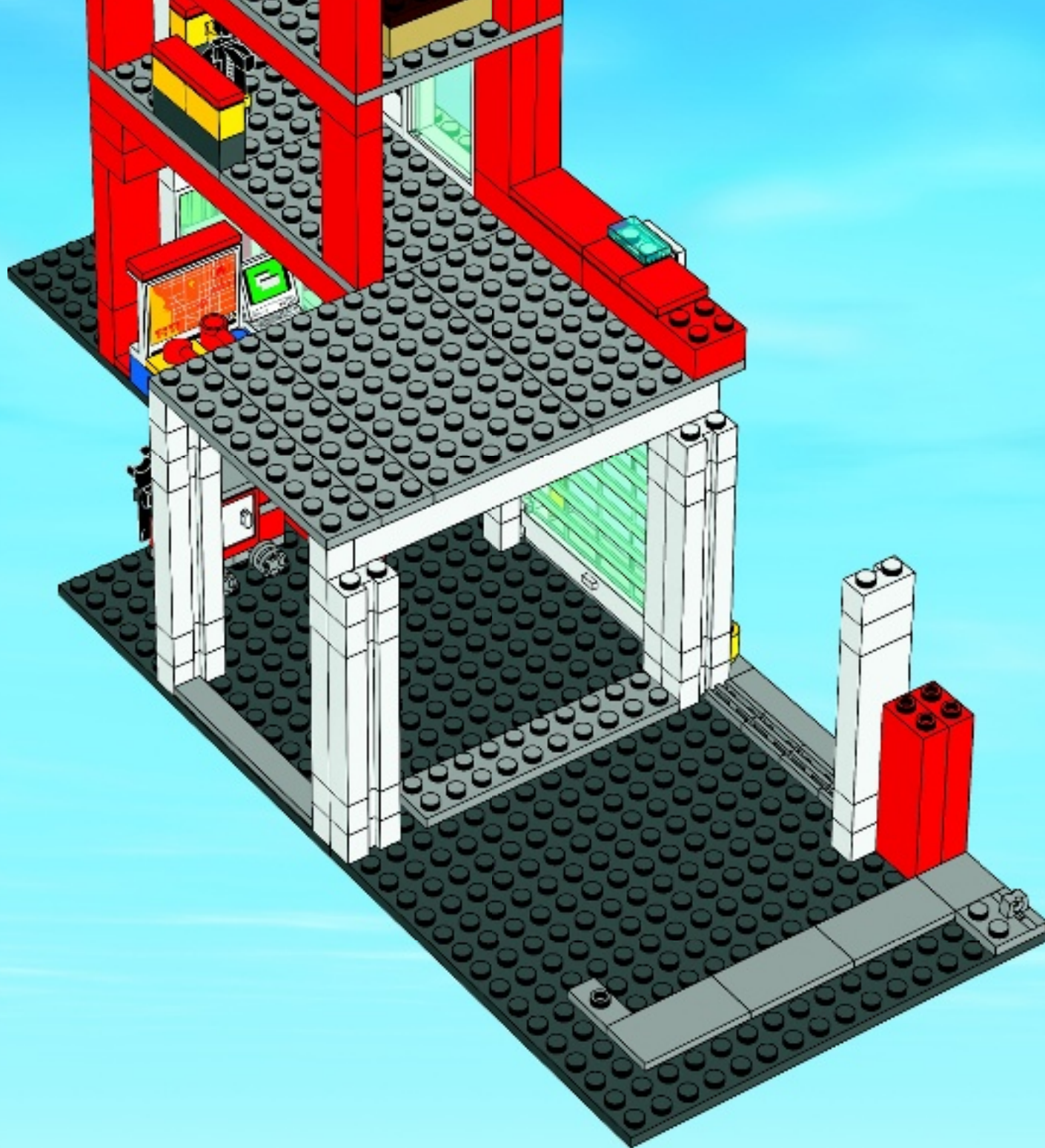



1x

75

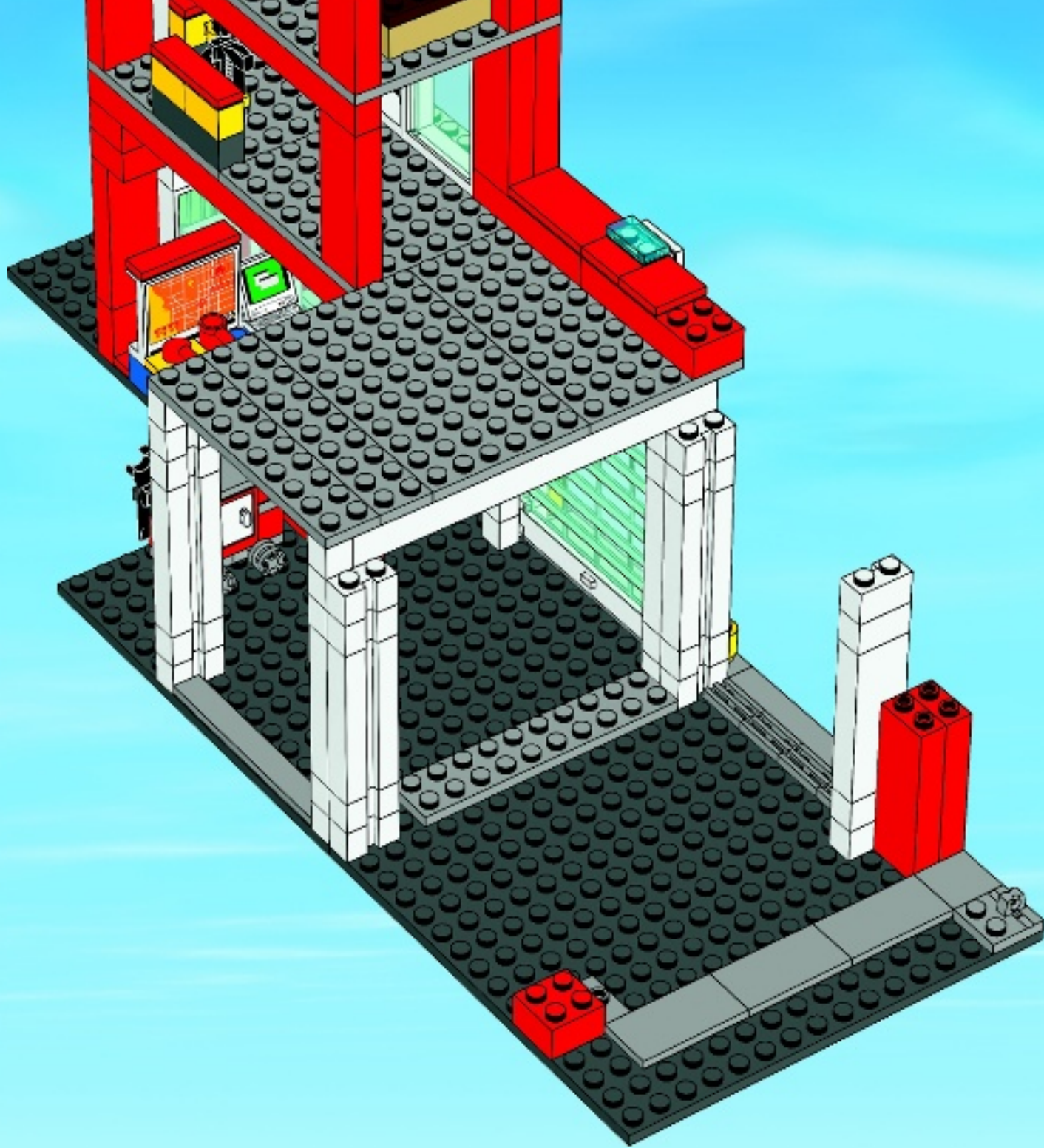

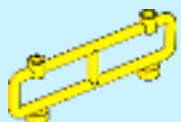

1x



1x



1x

76

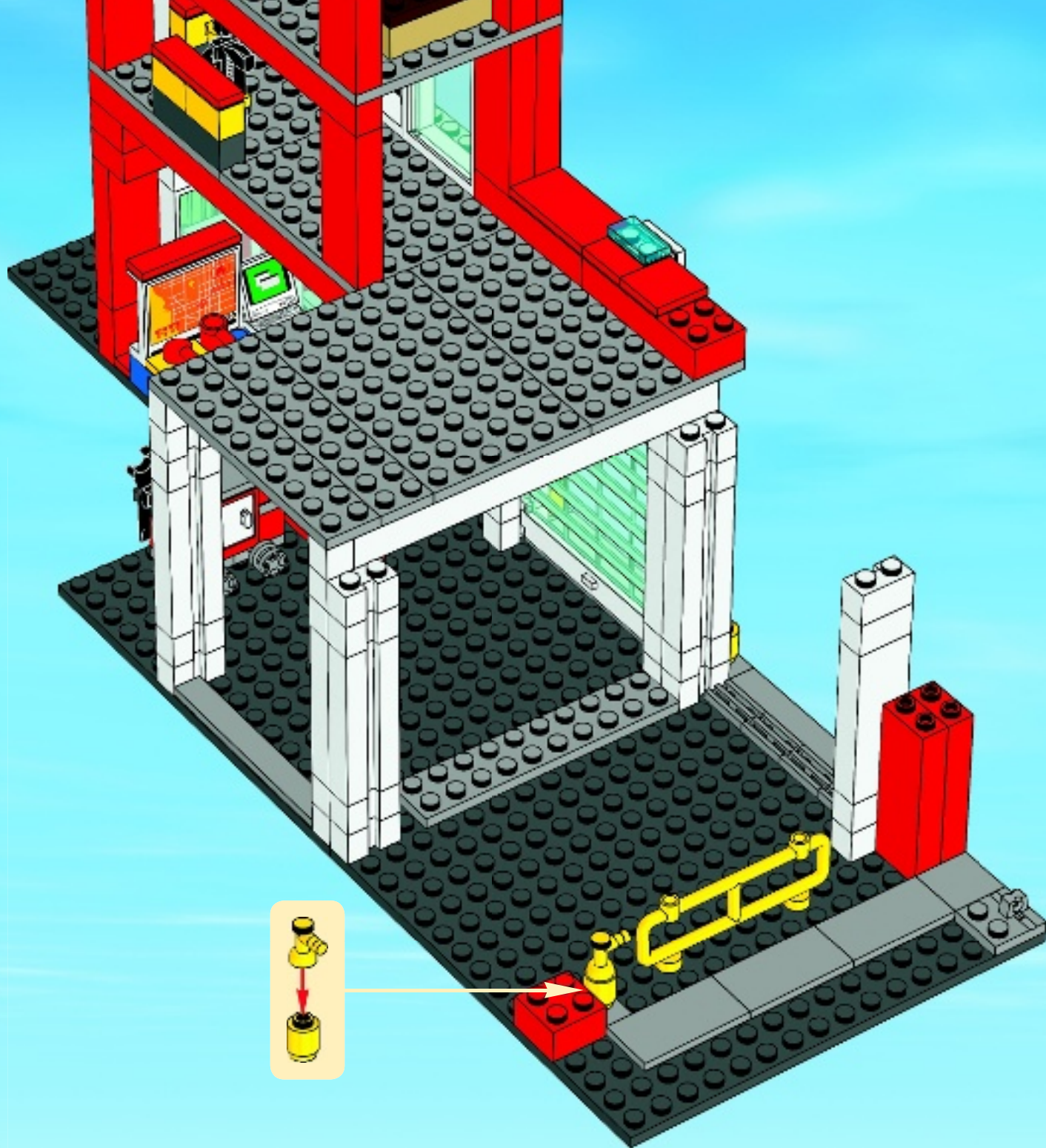

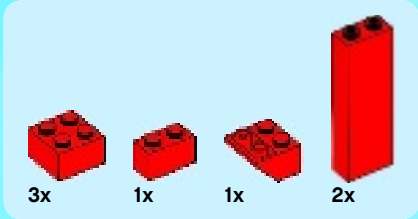

77

1

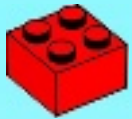

2



3

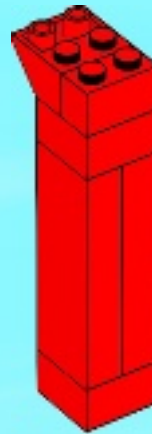

4

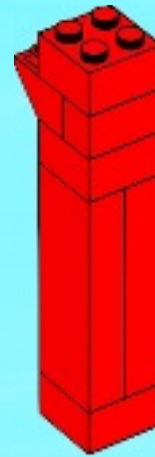

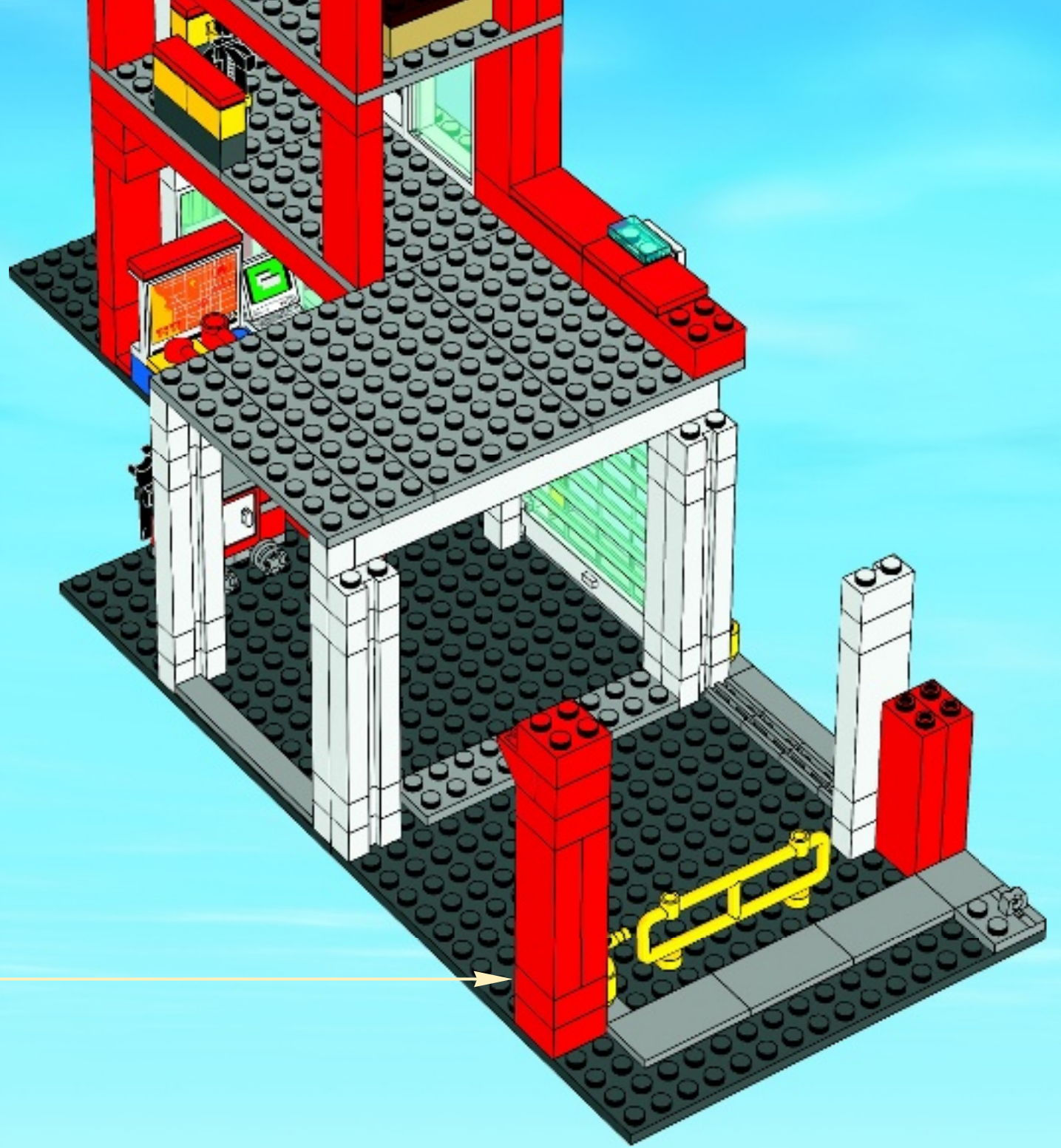

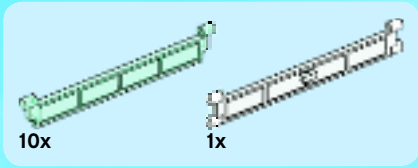

78

1

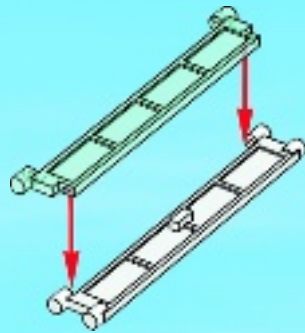

2

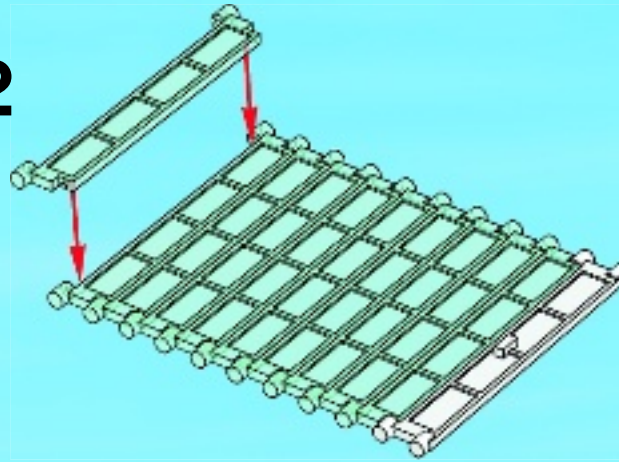

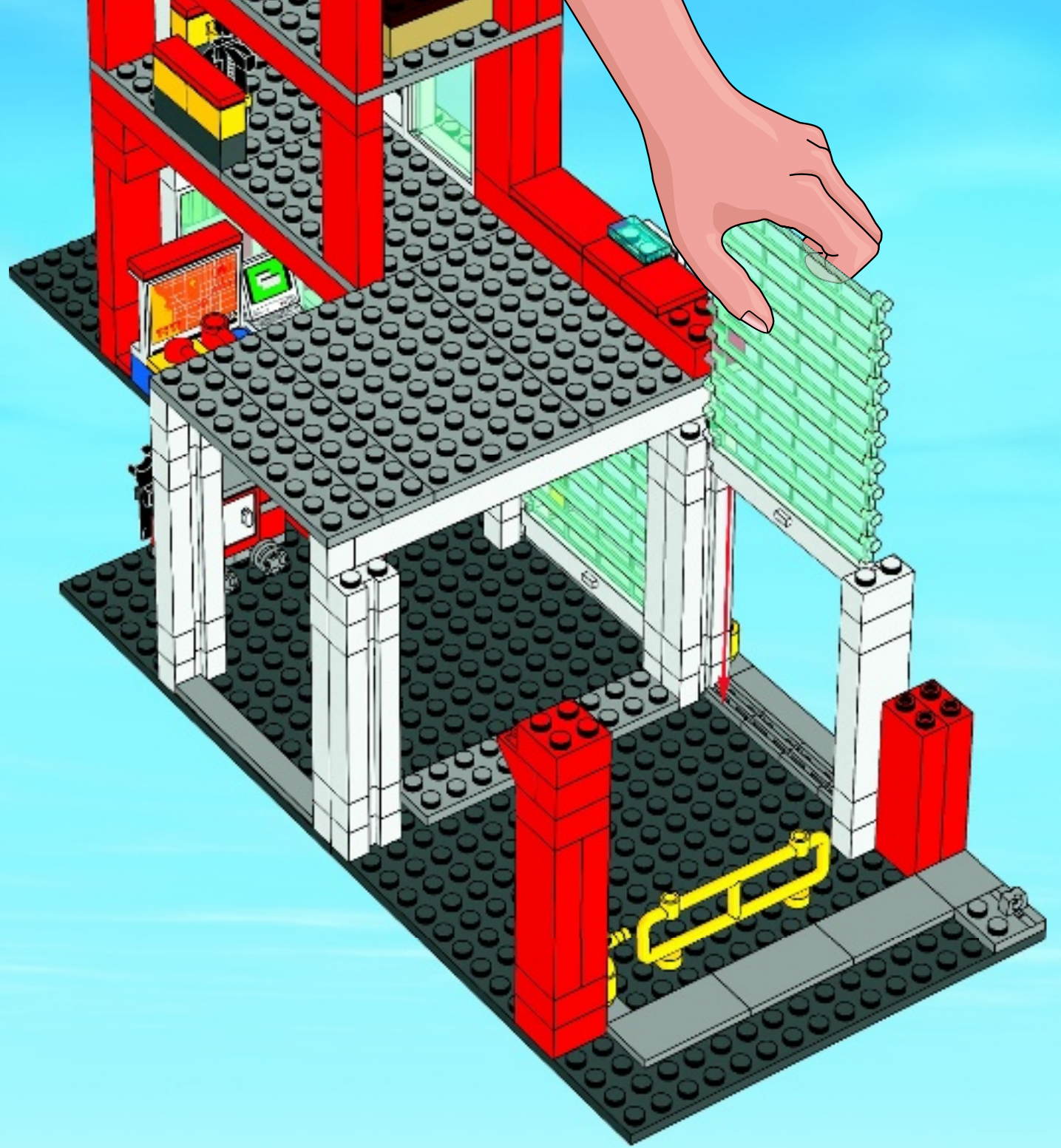

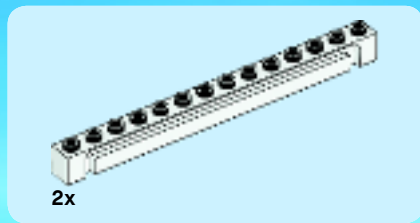

79

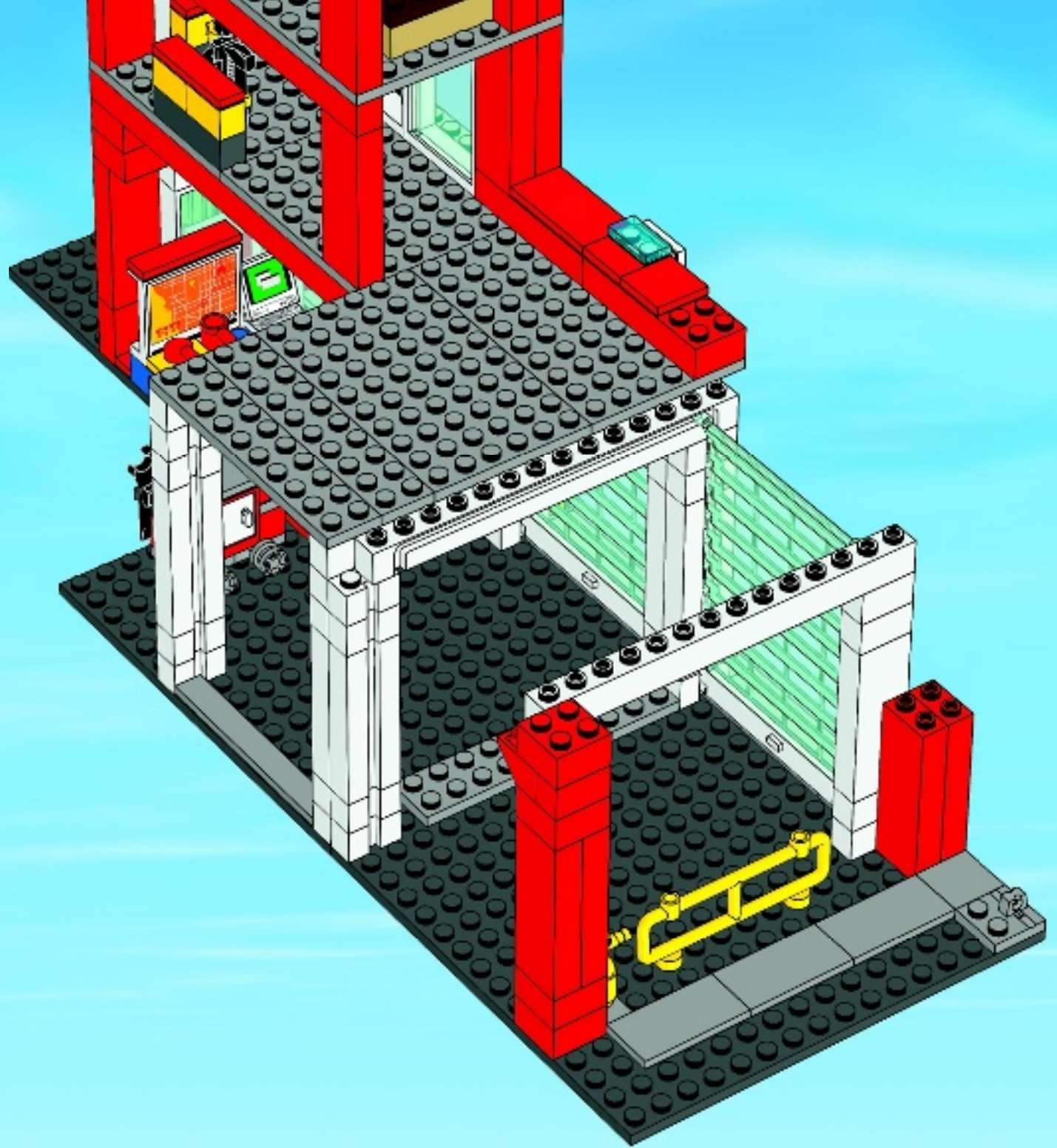

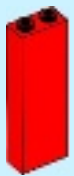

2x

80

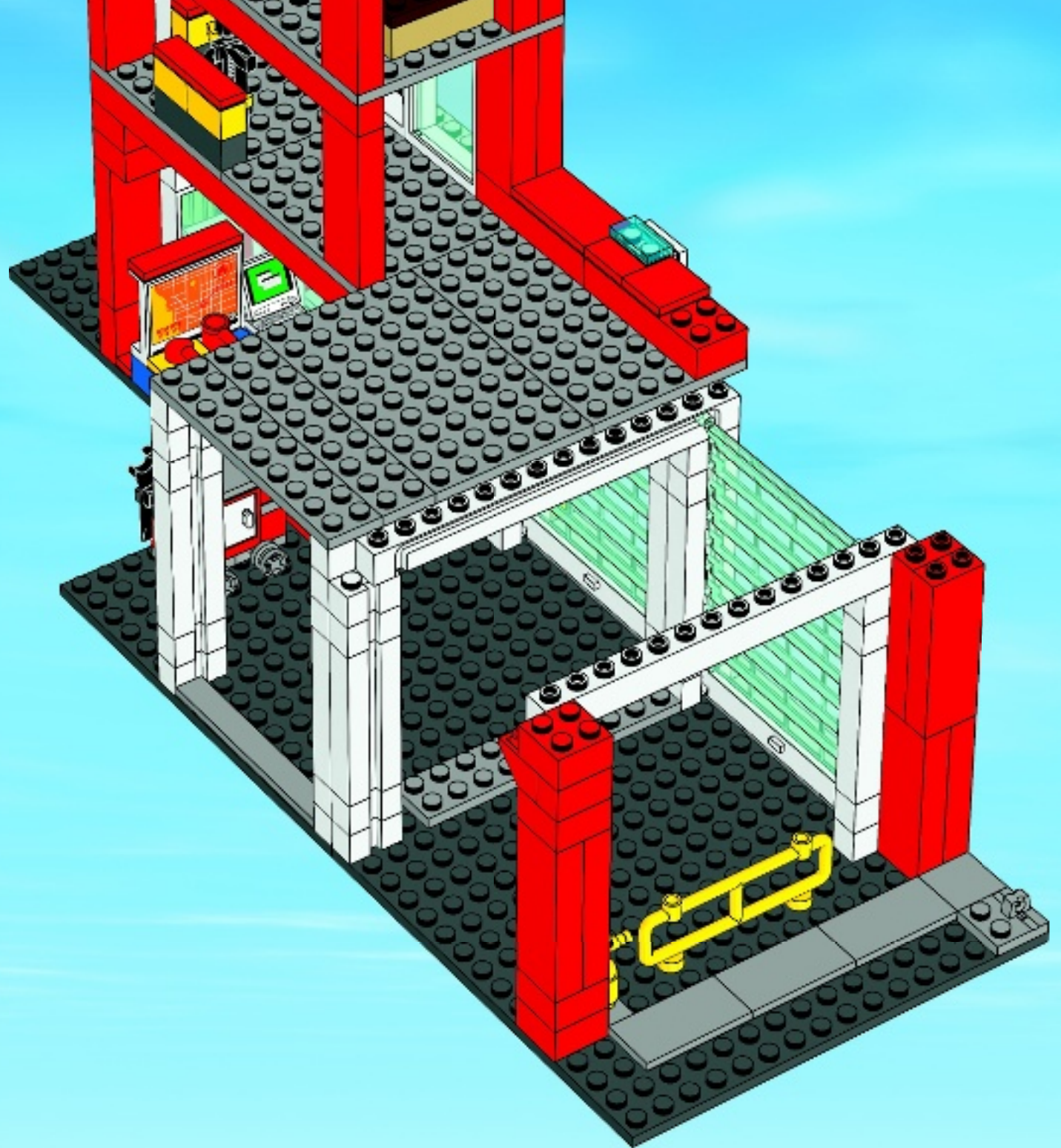

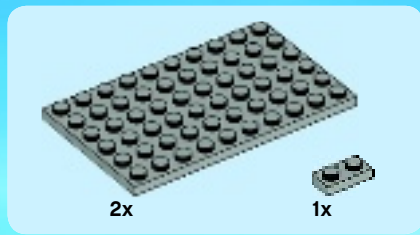

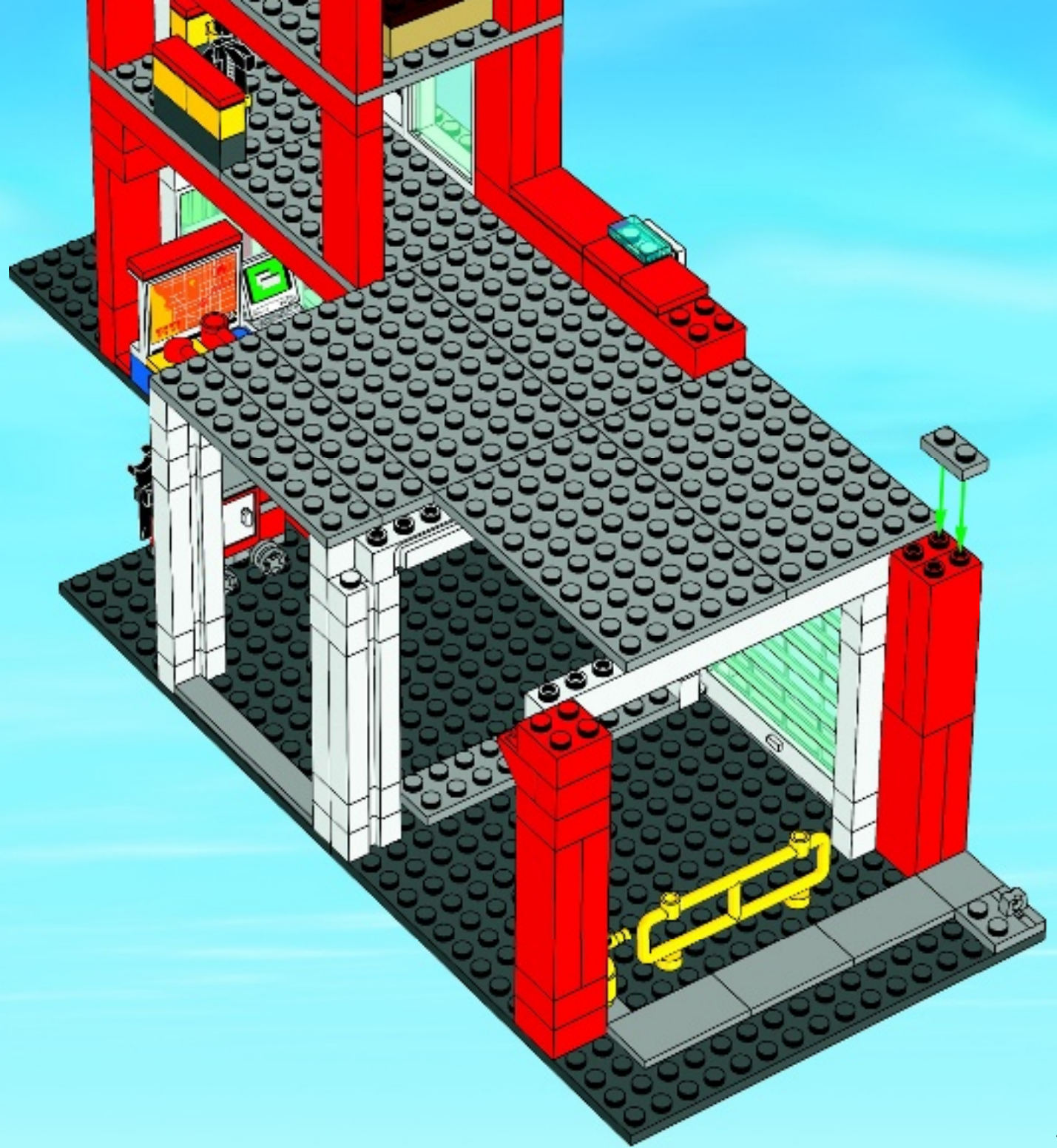

81

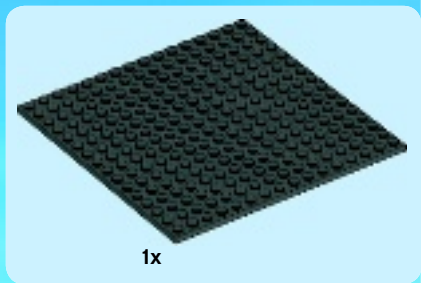

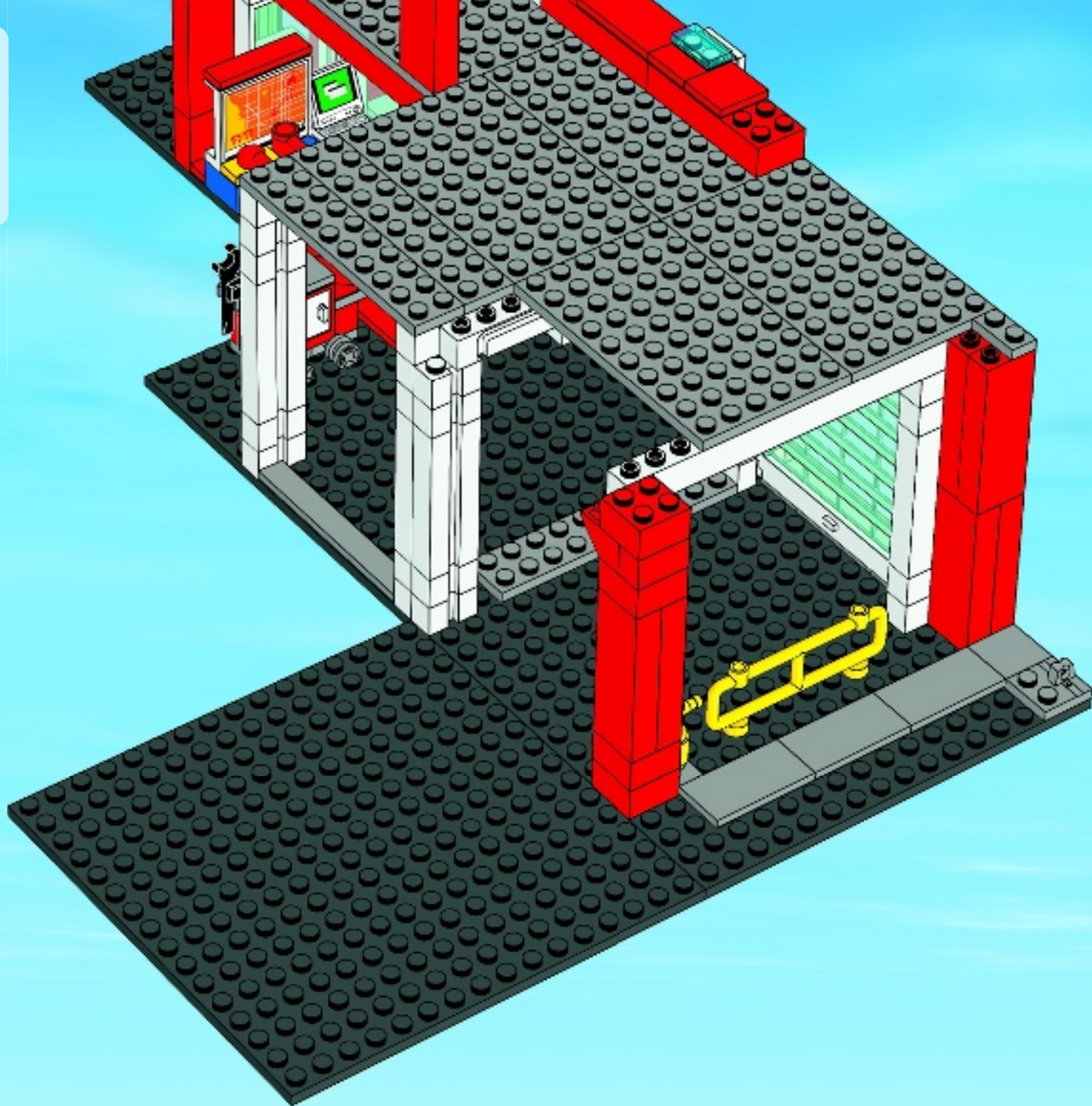

82



1x  3x 

83

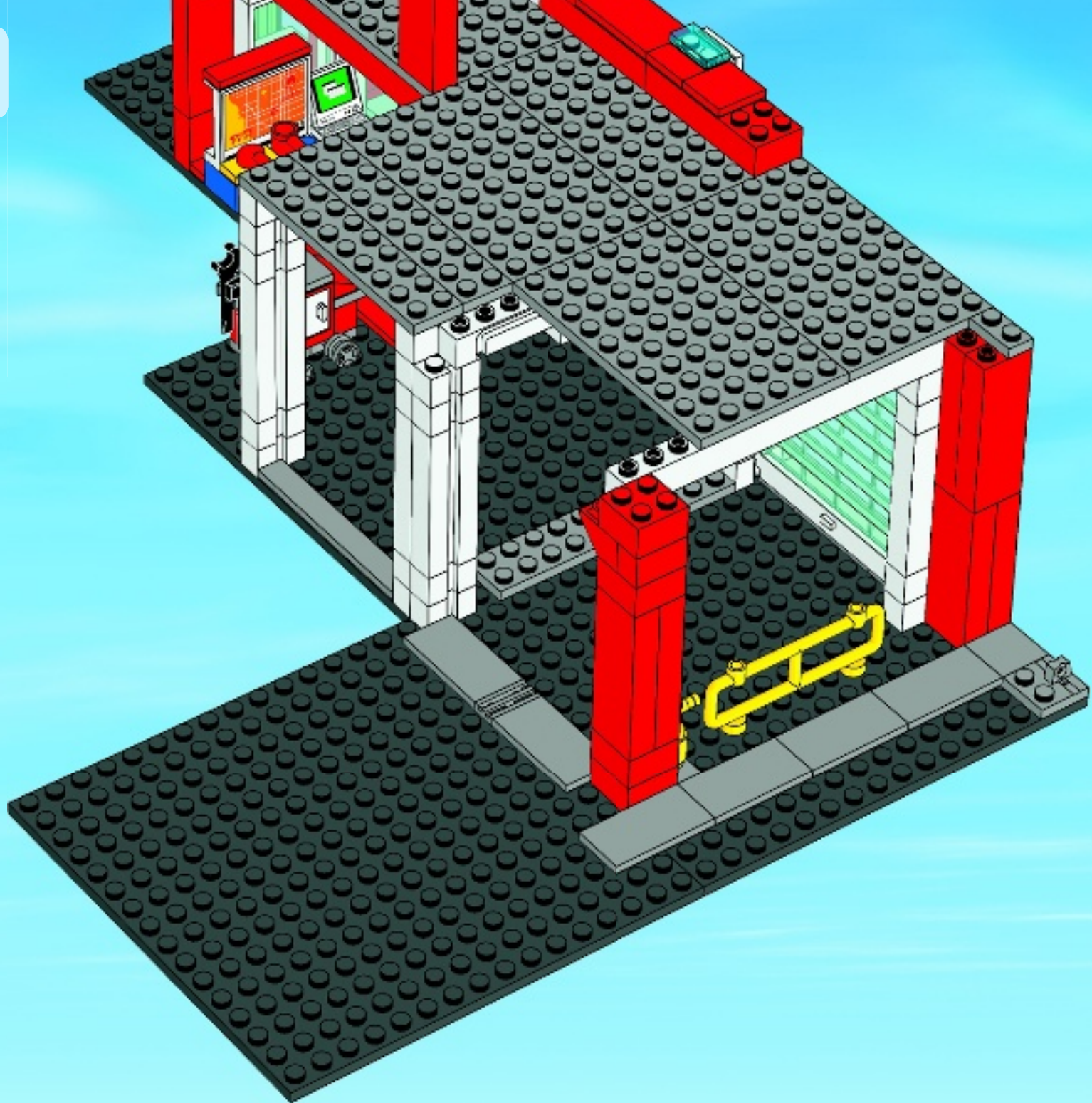

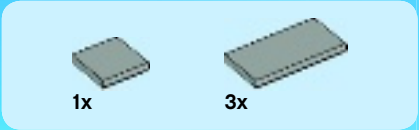

84

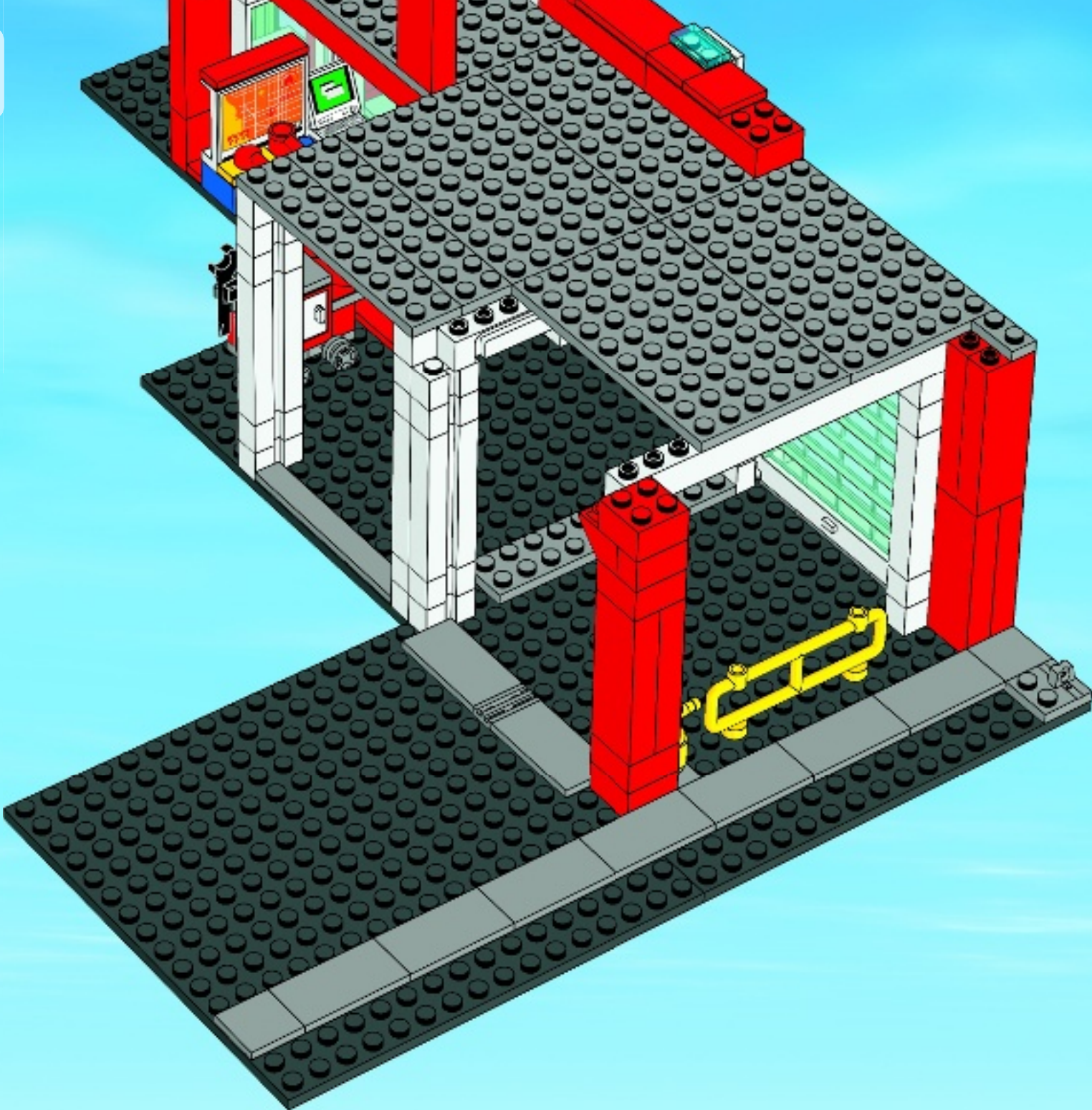



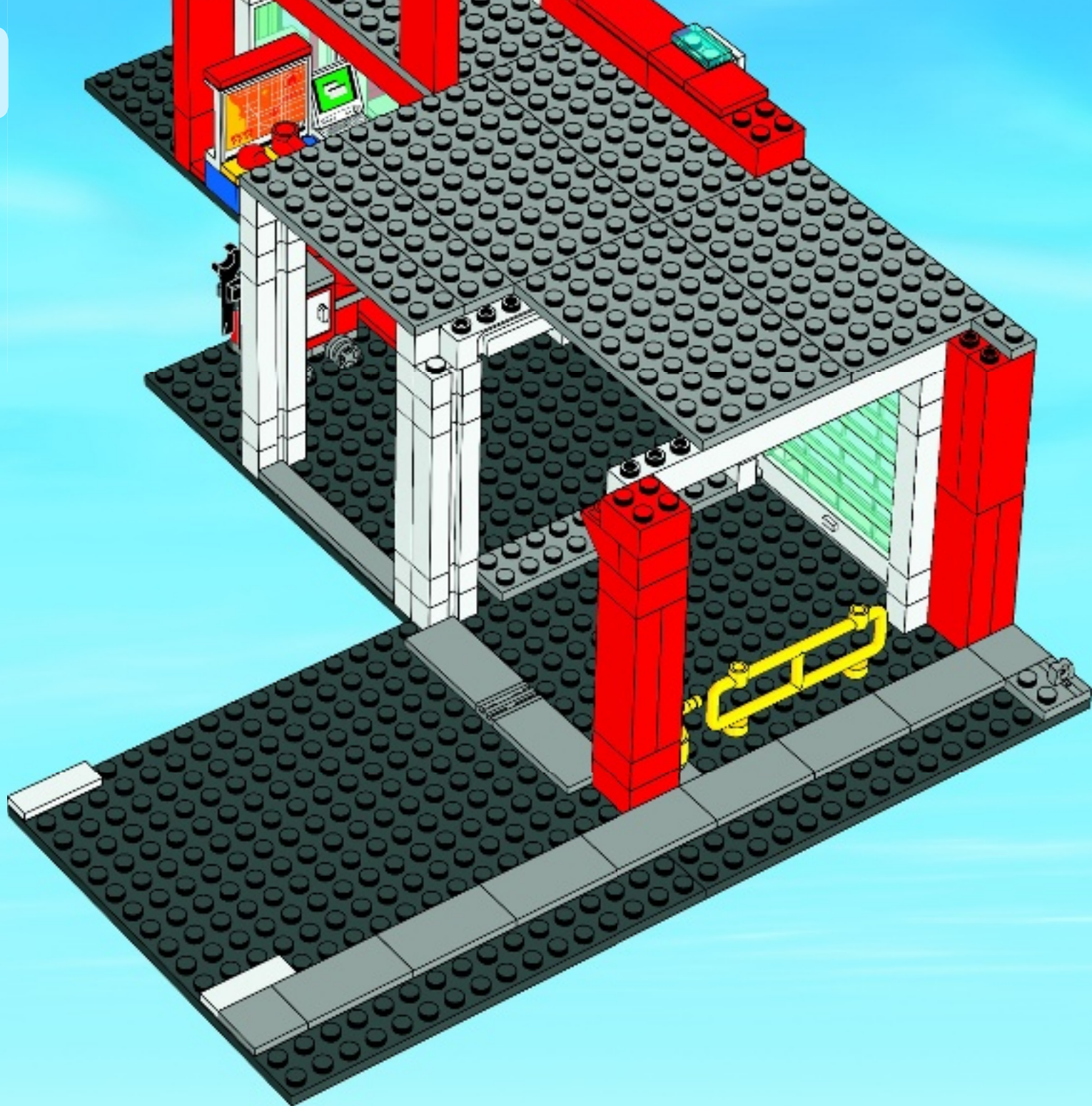

2x

85



1x  1x  1x 

86

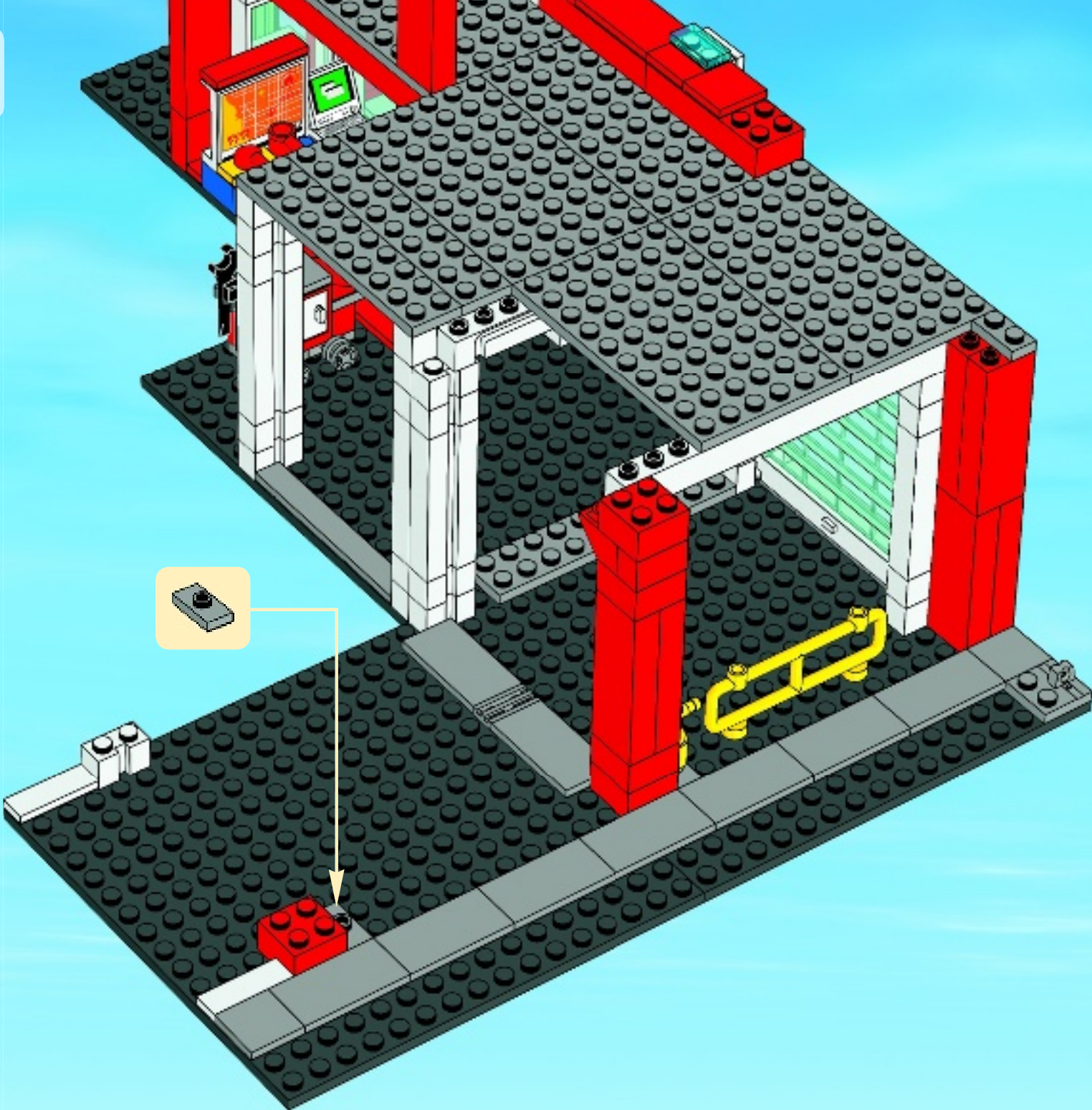

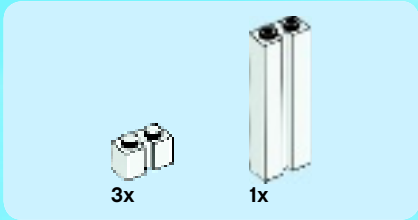
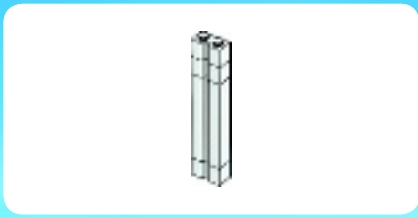

87

1

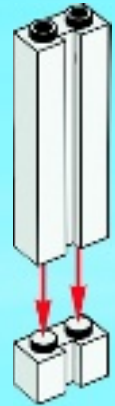

2

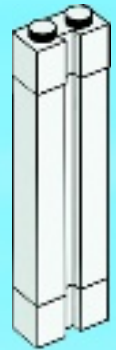

3

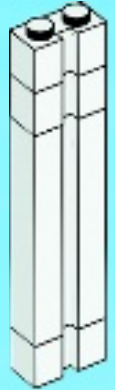

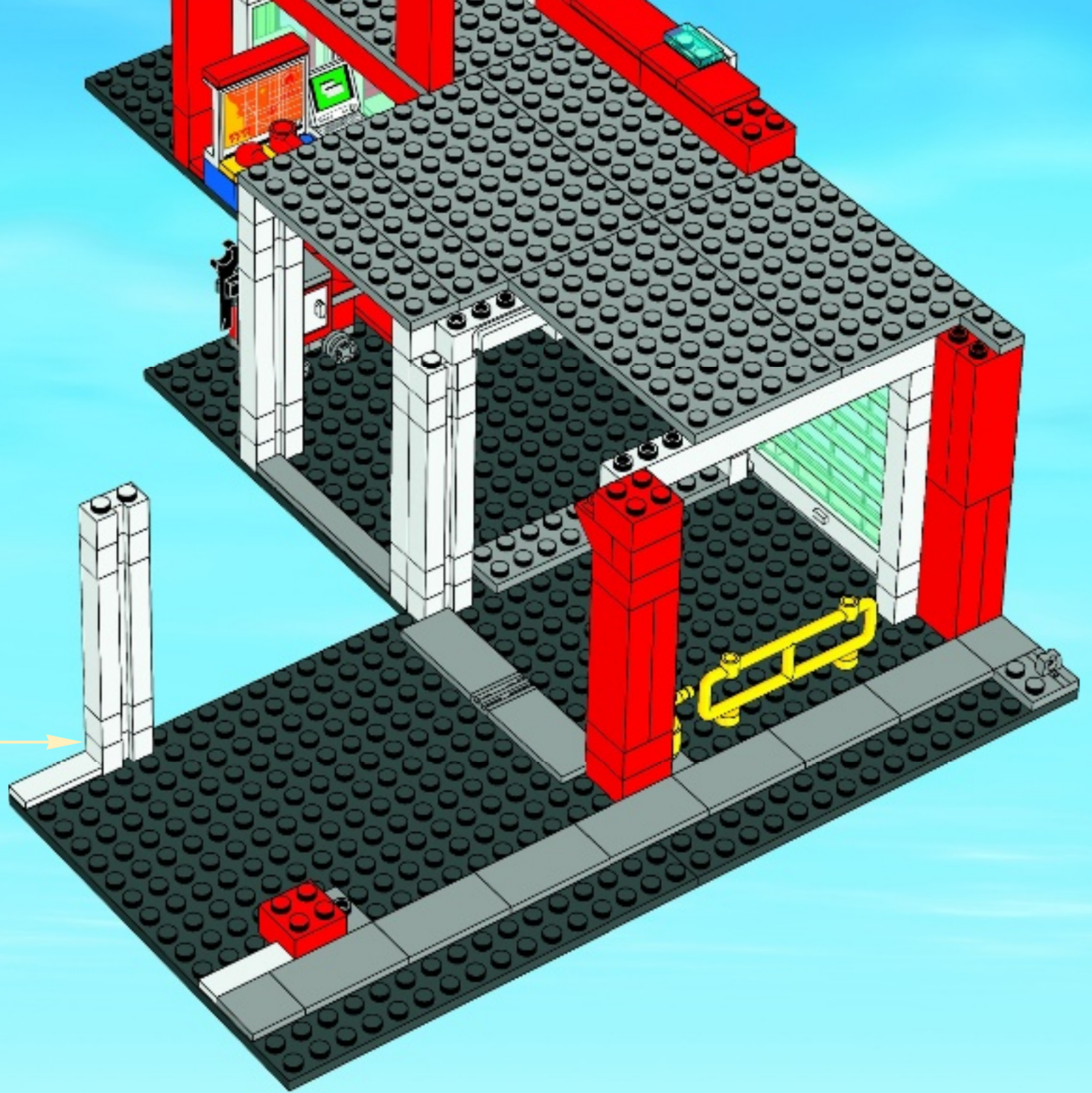

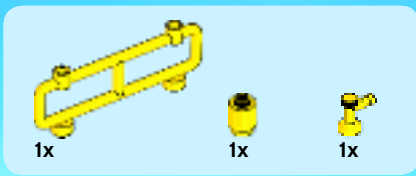

88

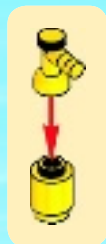
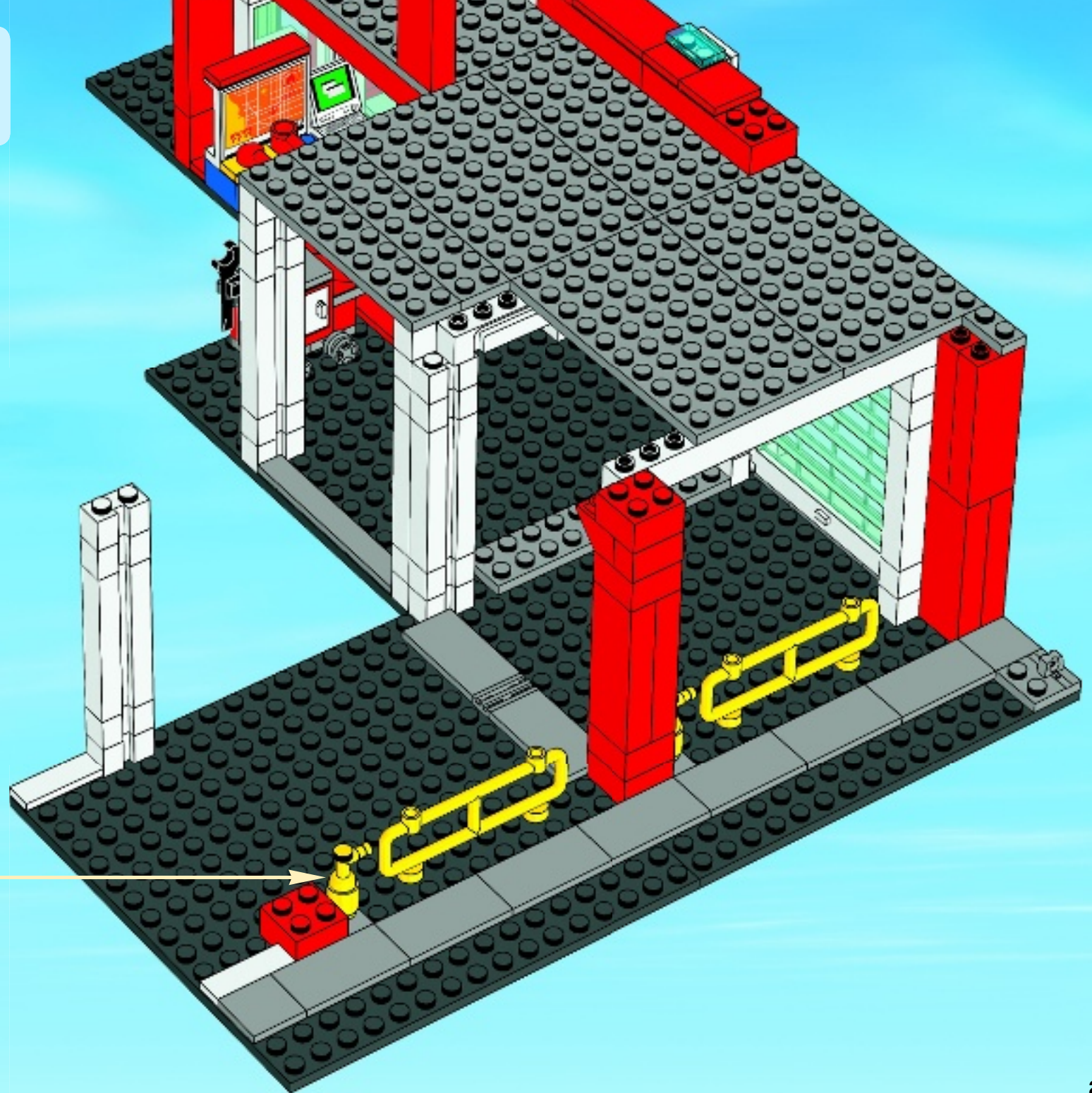

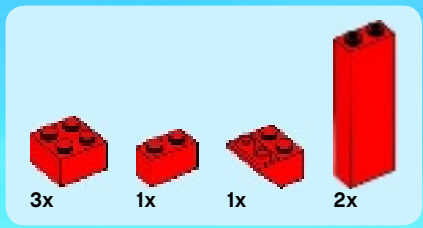

89

1



2



3



4

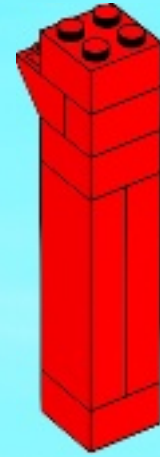

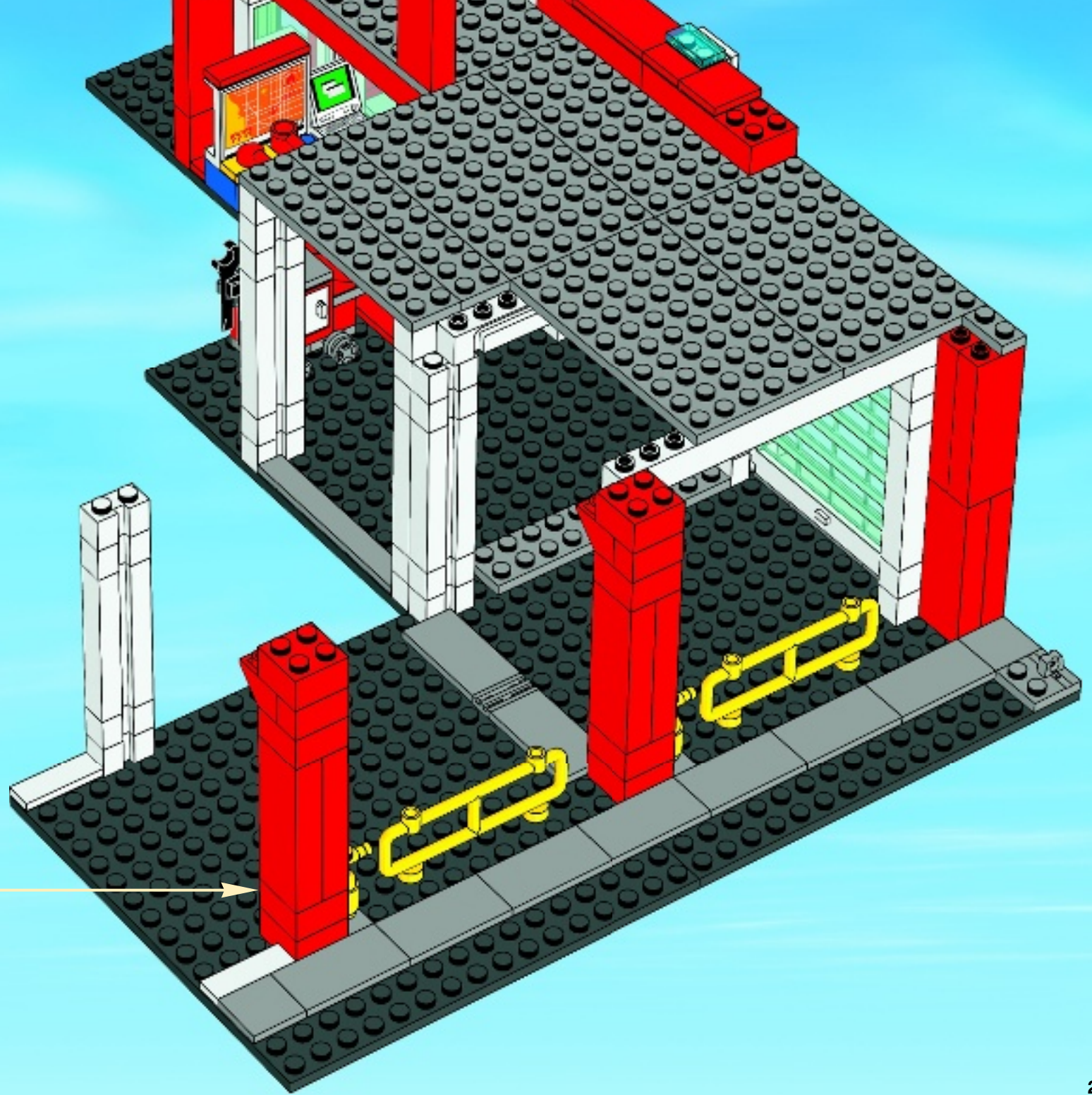



90

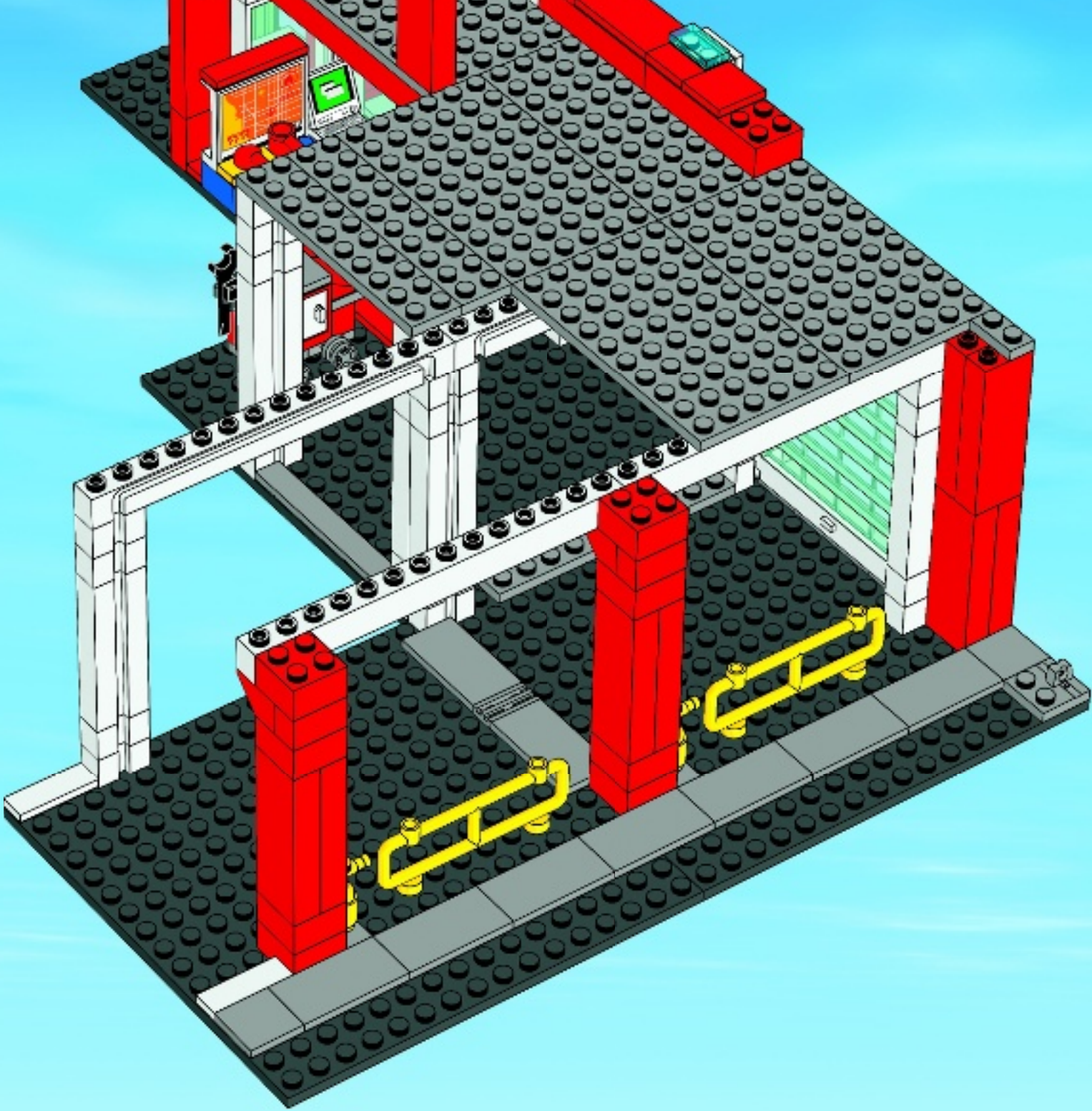

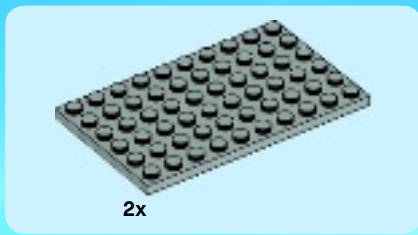

91

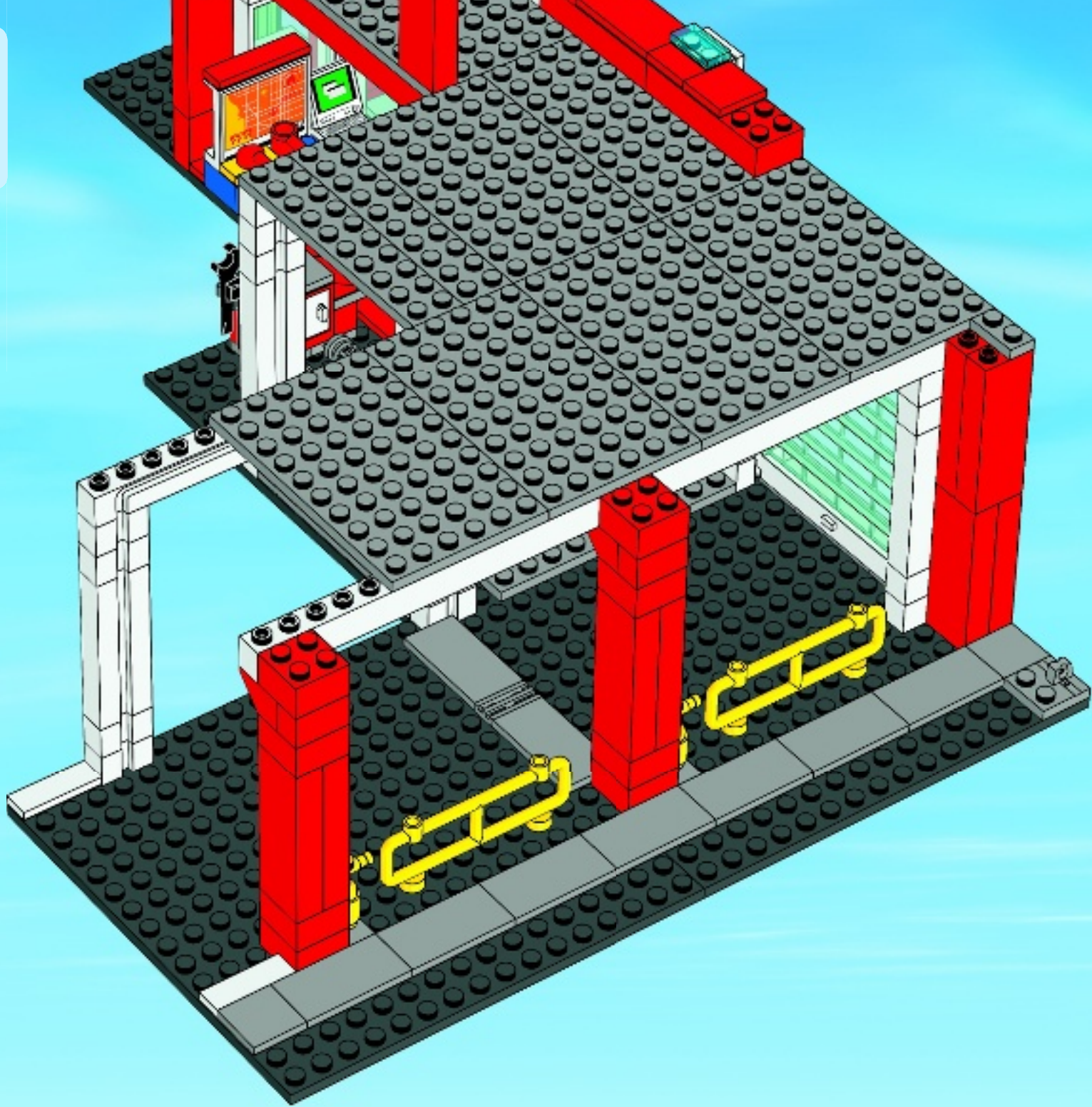

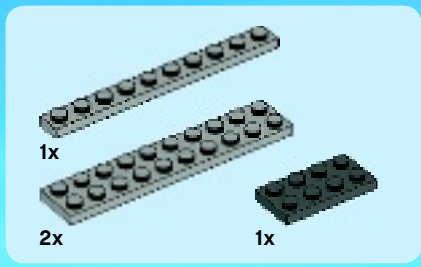

92

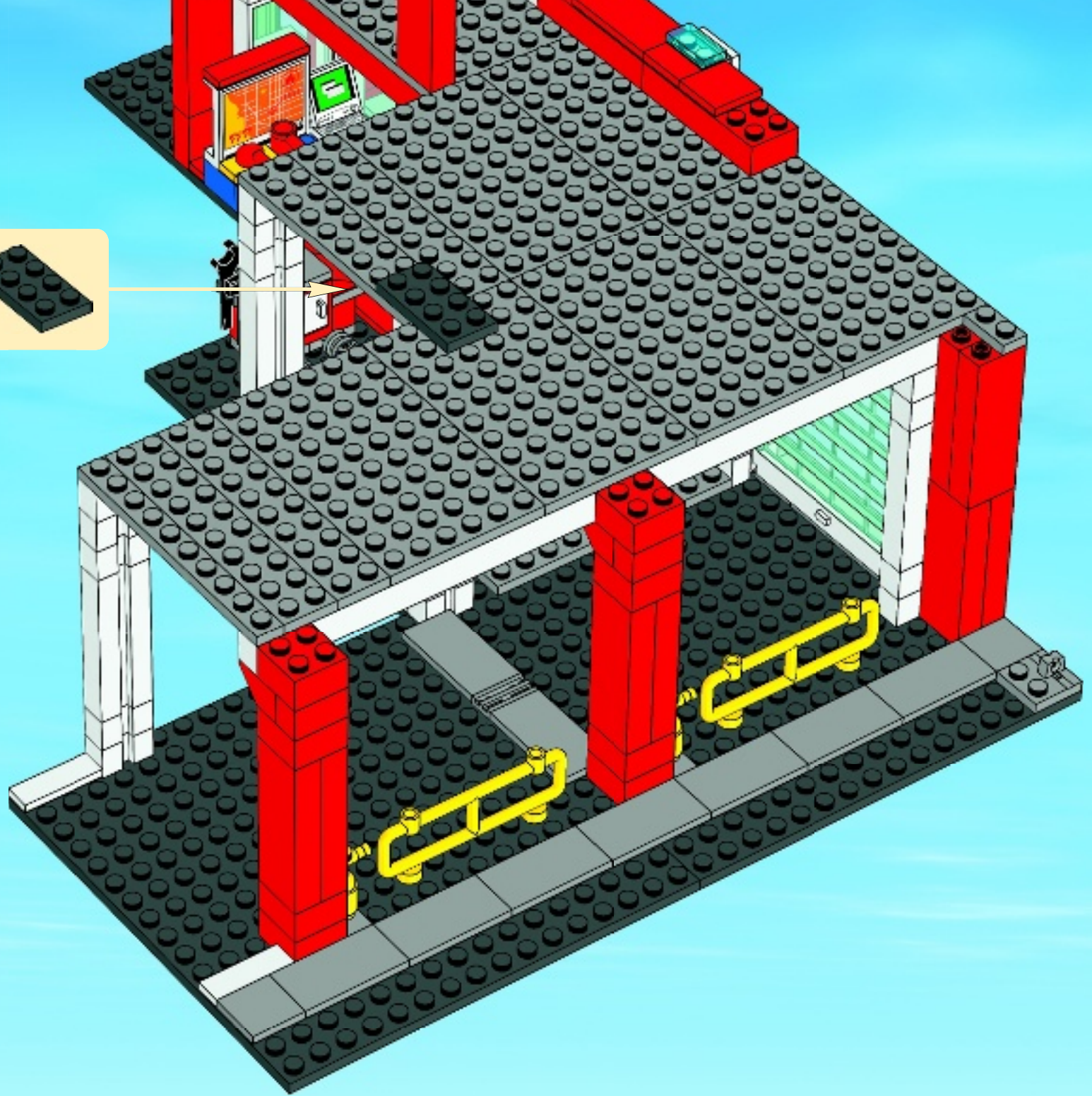

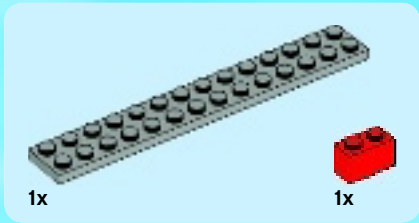
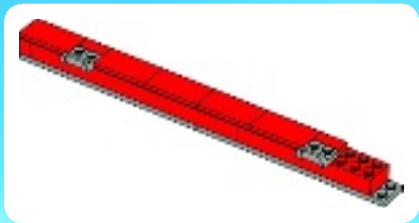
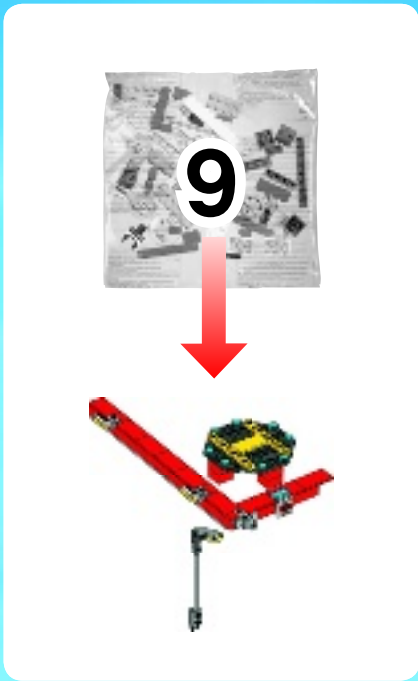

1

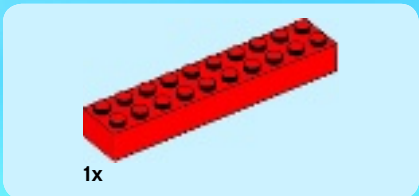
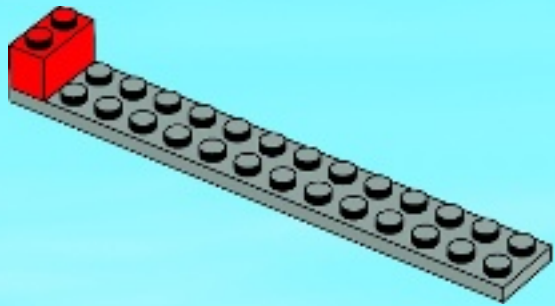

2

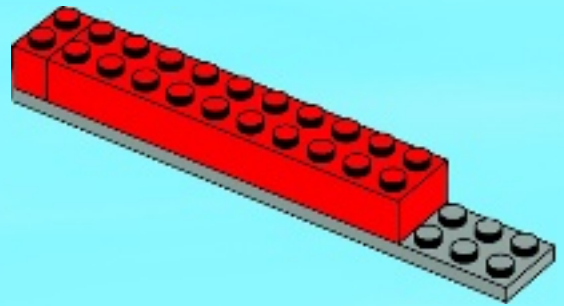



3

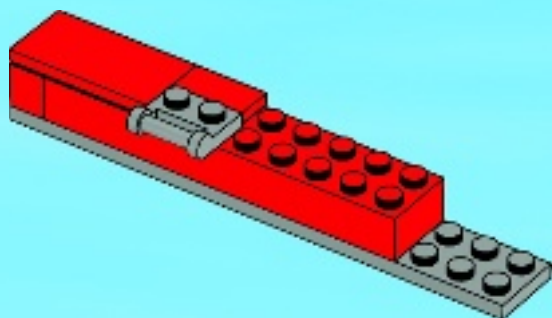

4

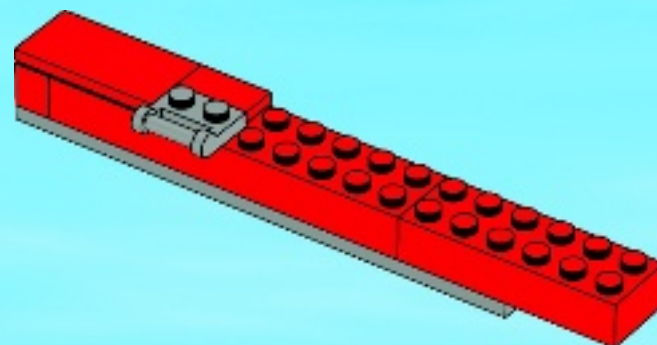

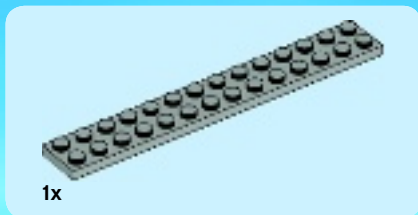

5

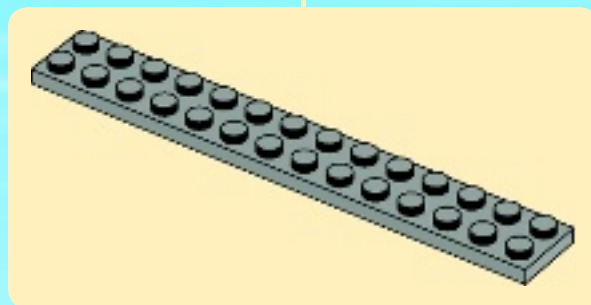
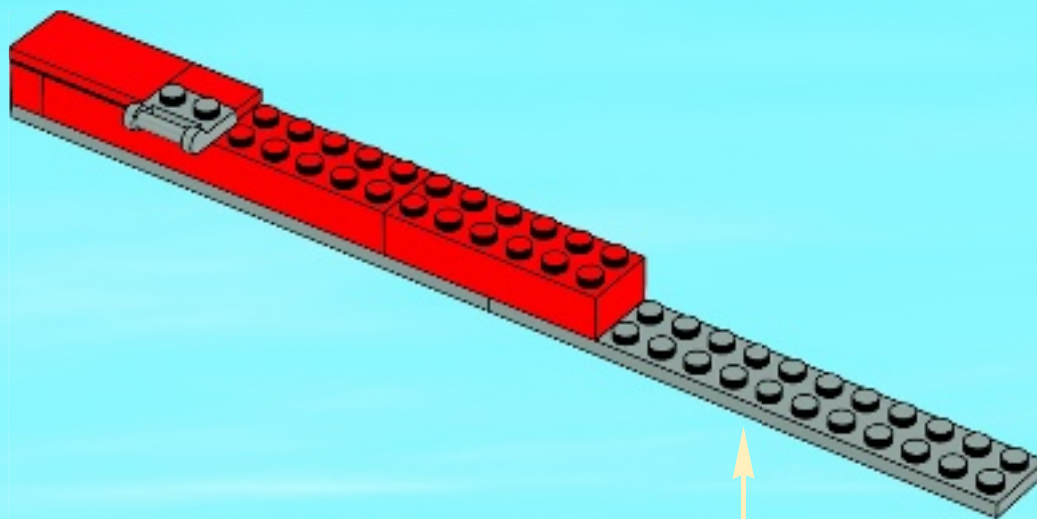



6

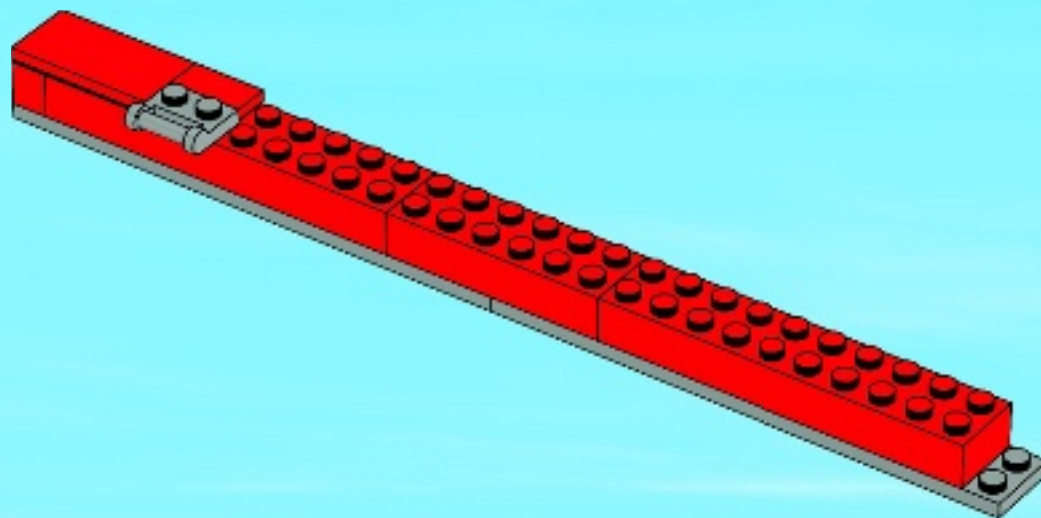

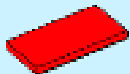

4x

7

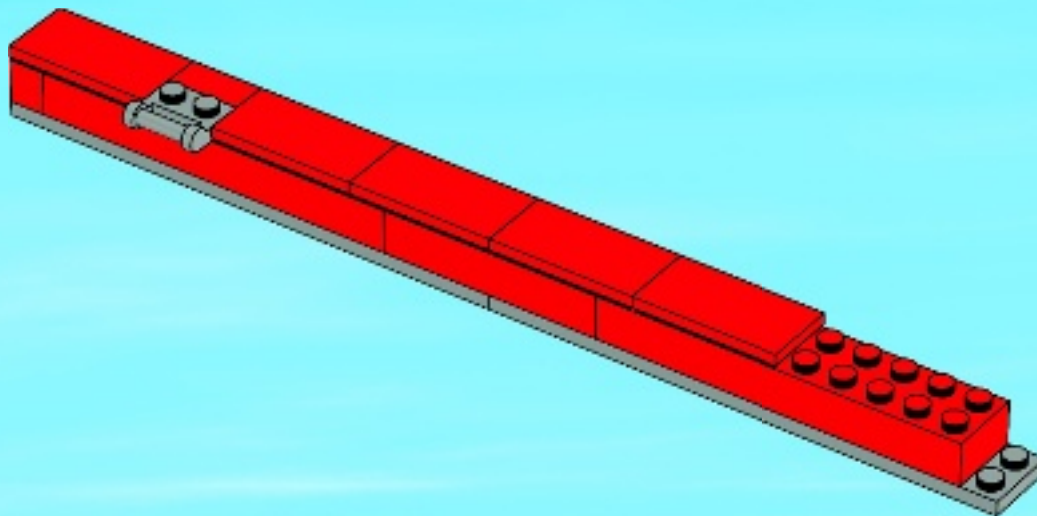



1x



1x

8

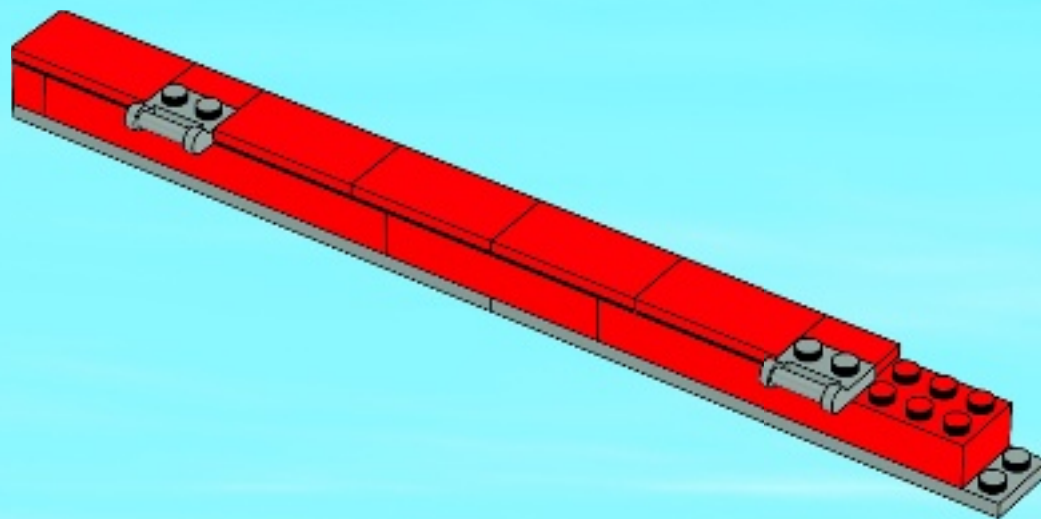

93

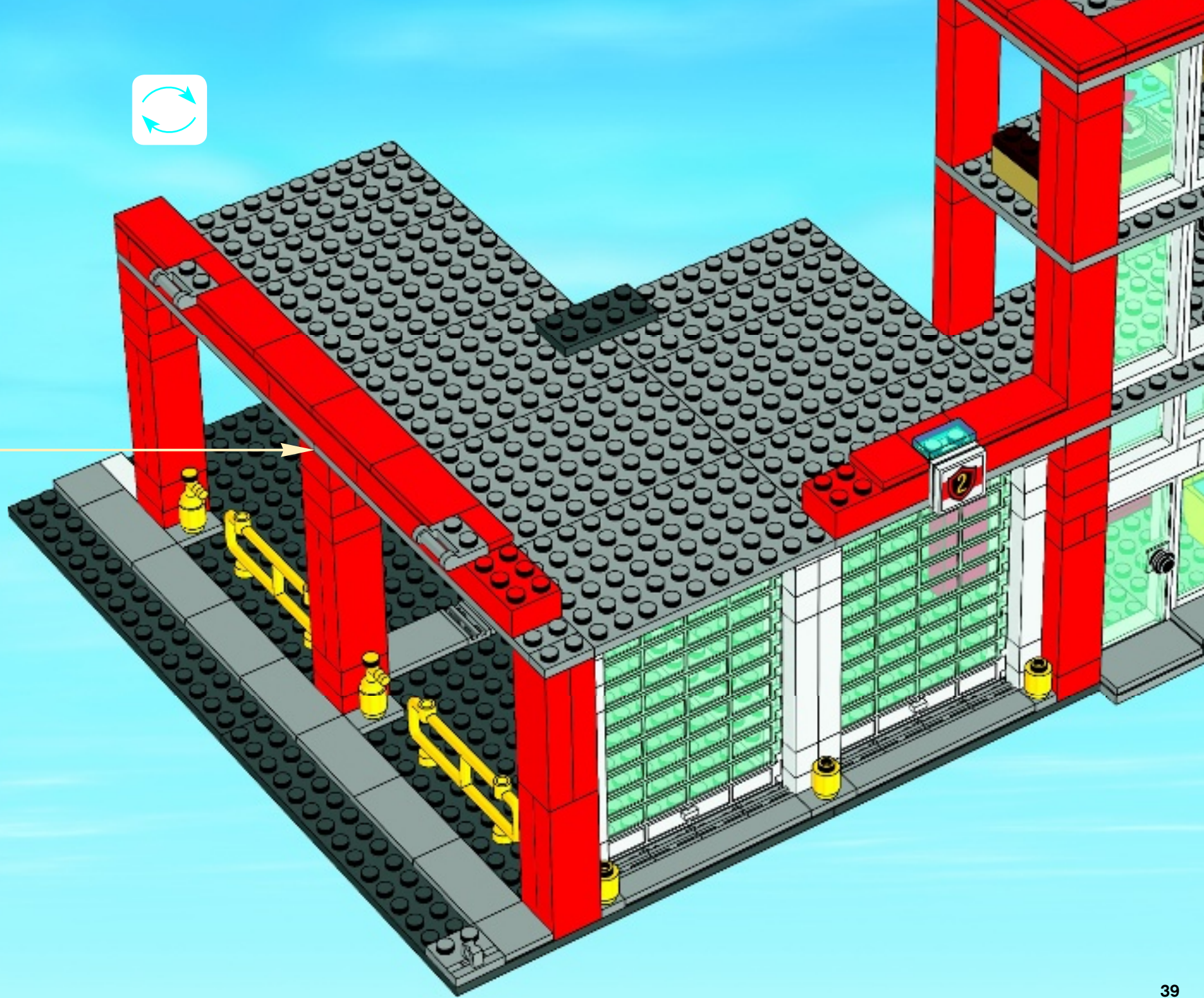



2x

94

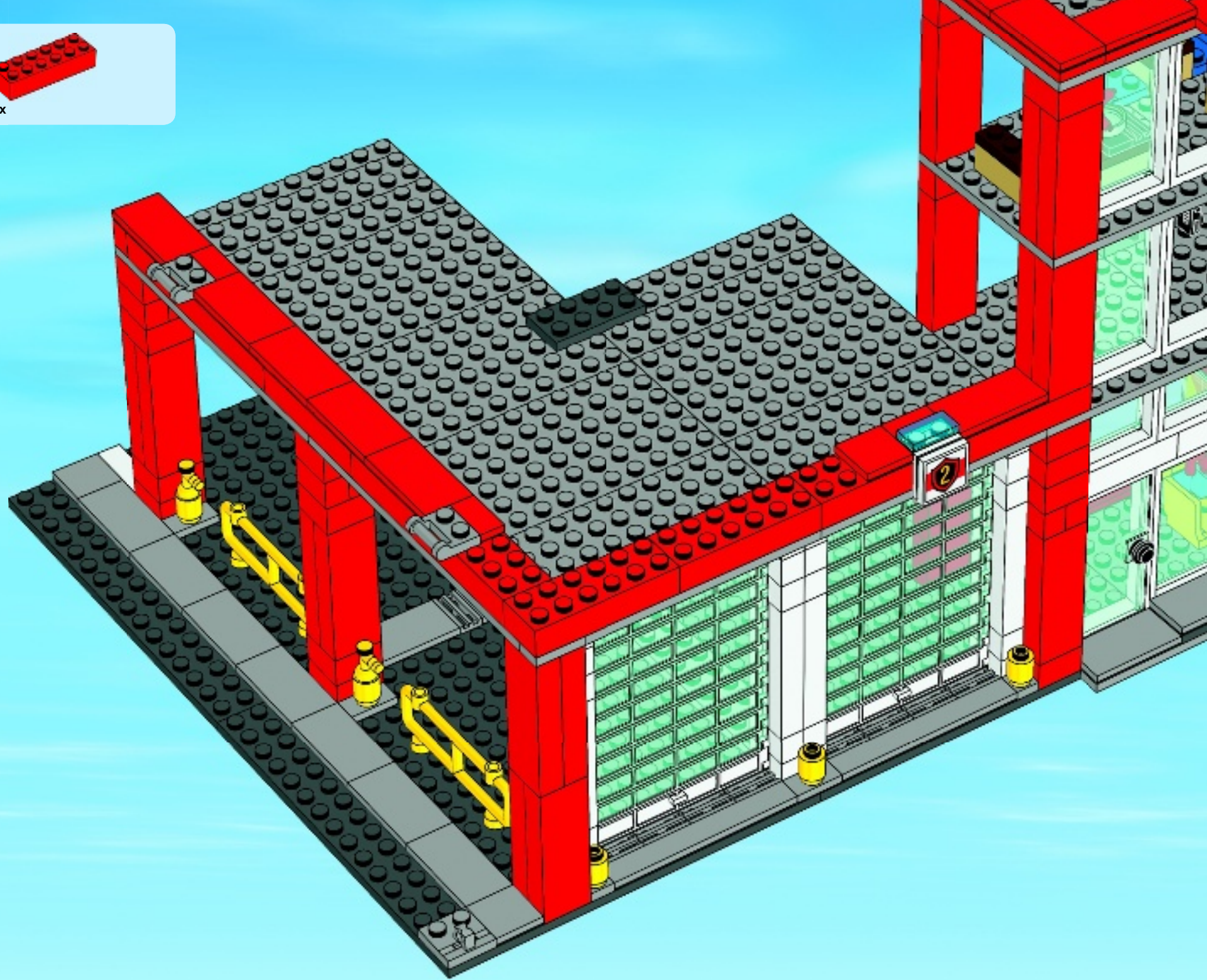



95



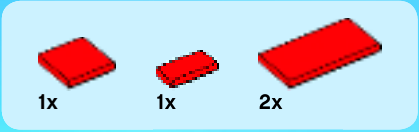

96

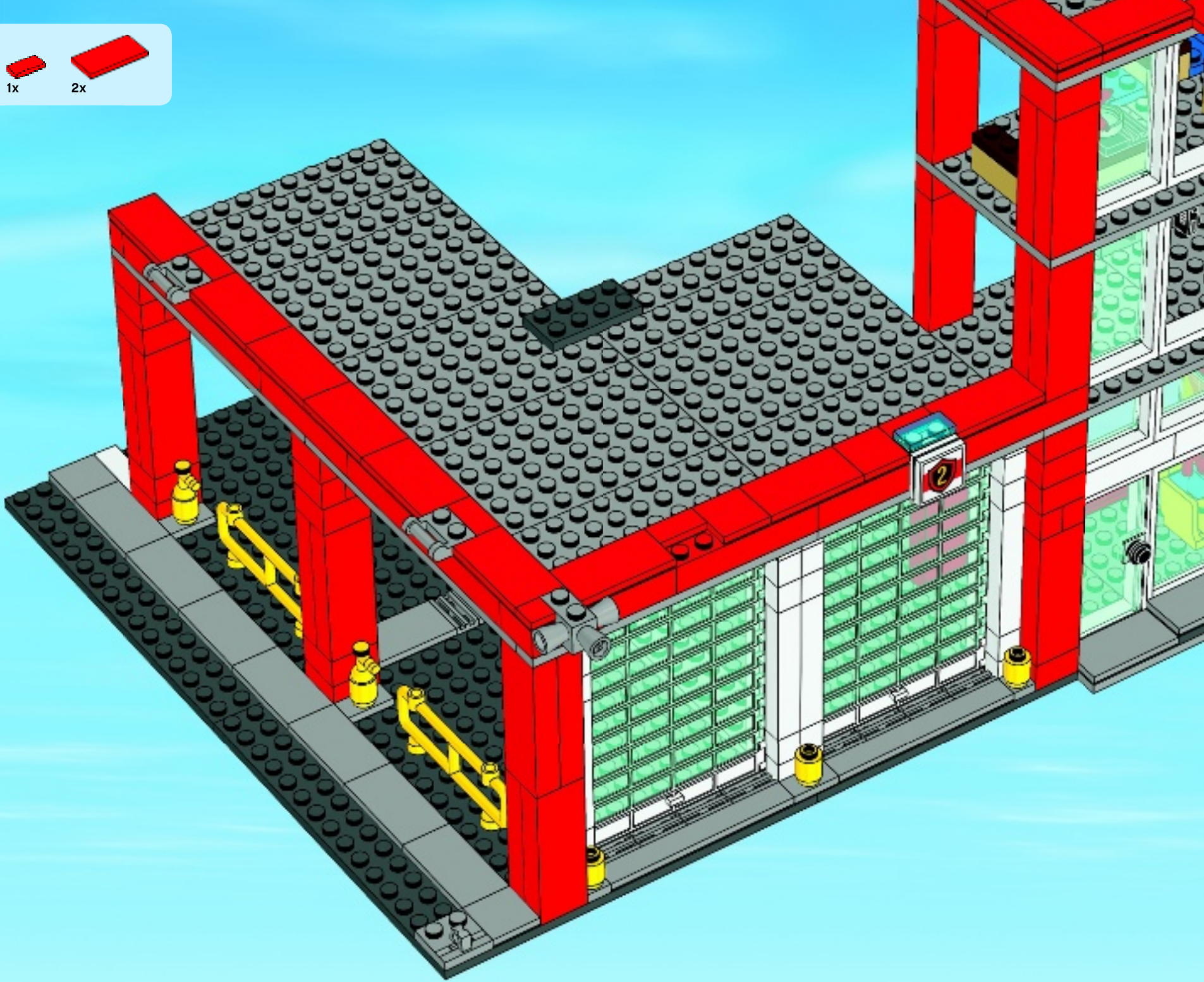

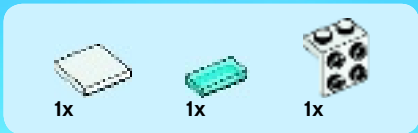

97

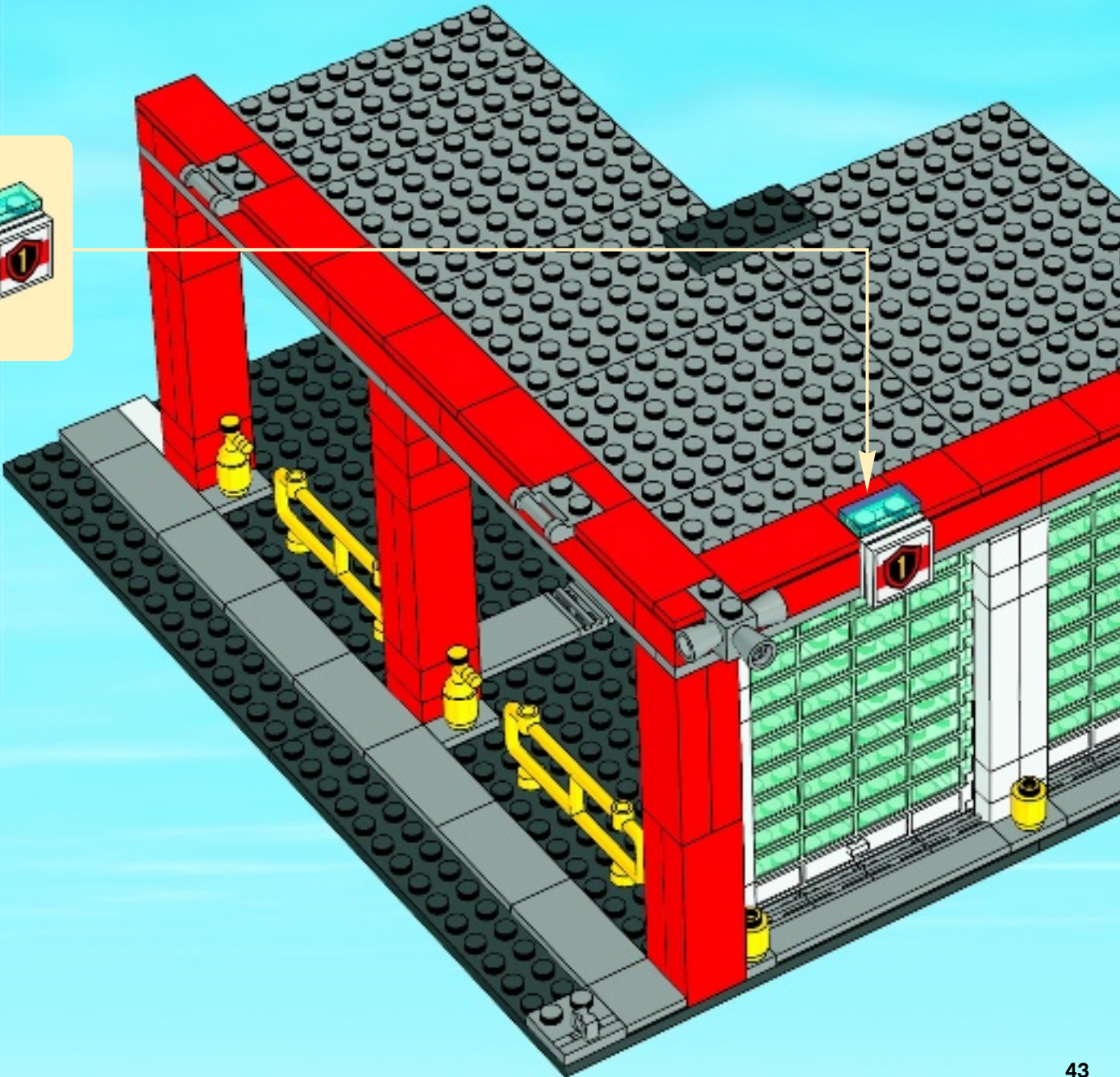
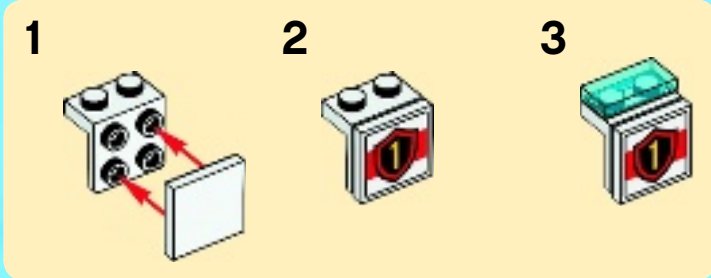



2x



2x

98

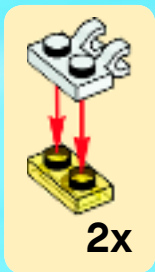

2x

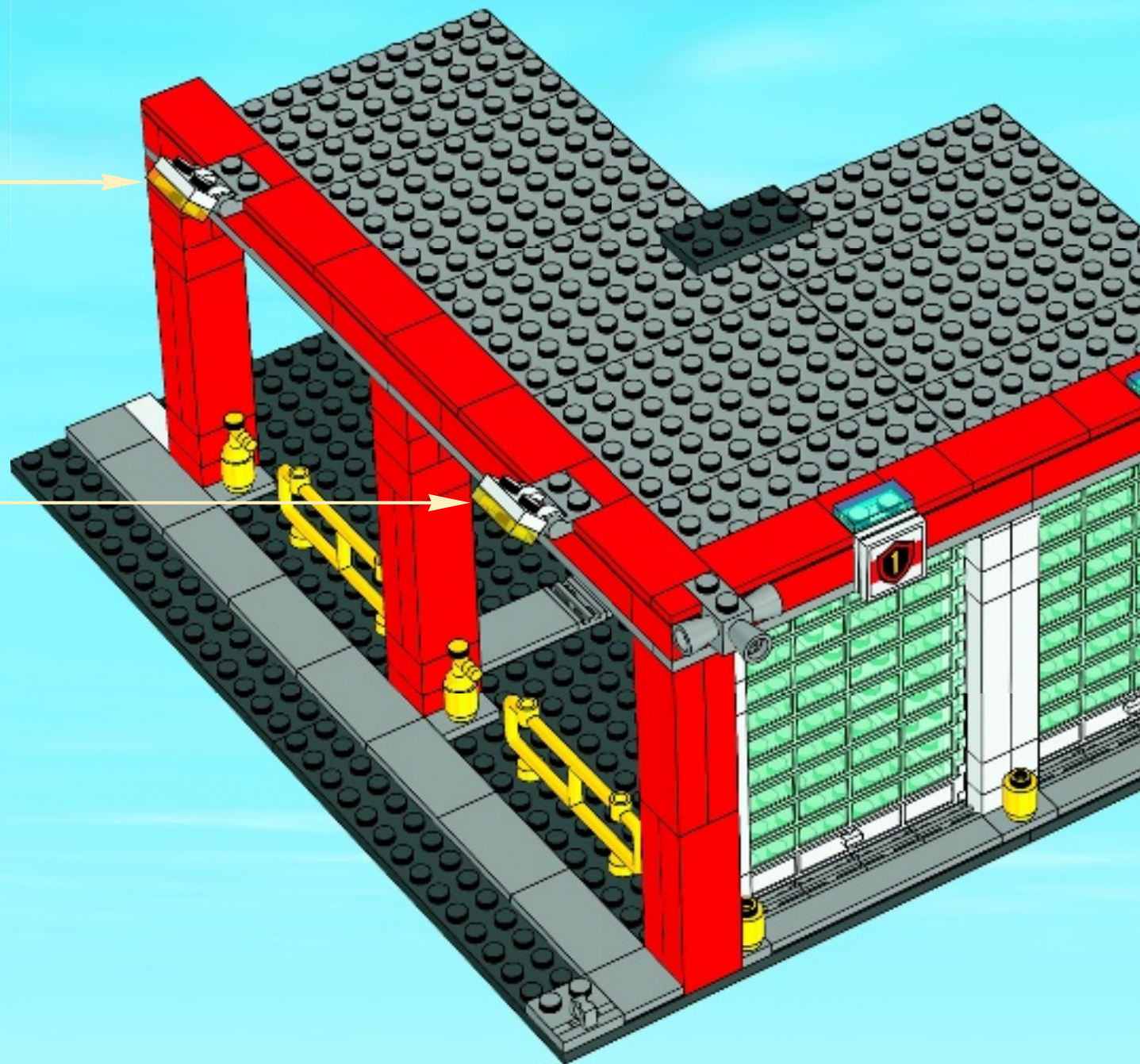

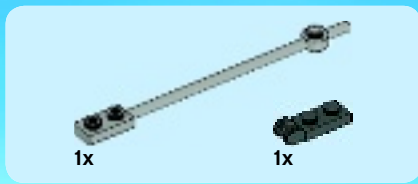

99

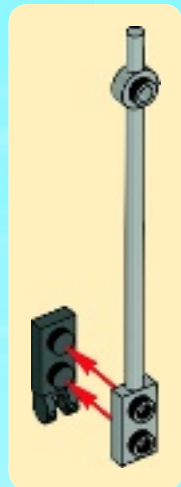
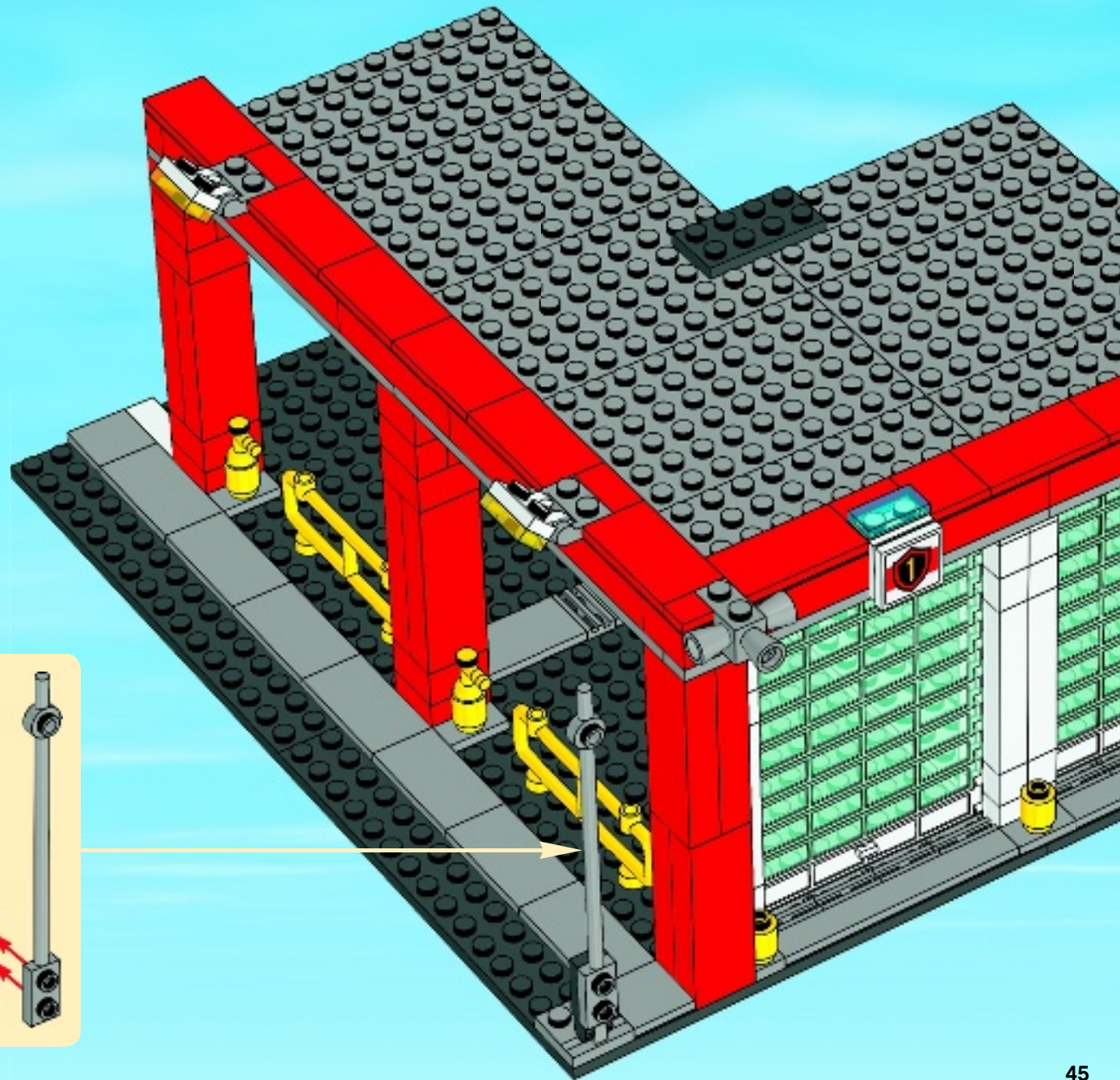



1x



1x

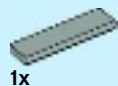

1x



1x

100

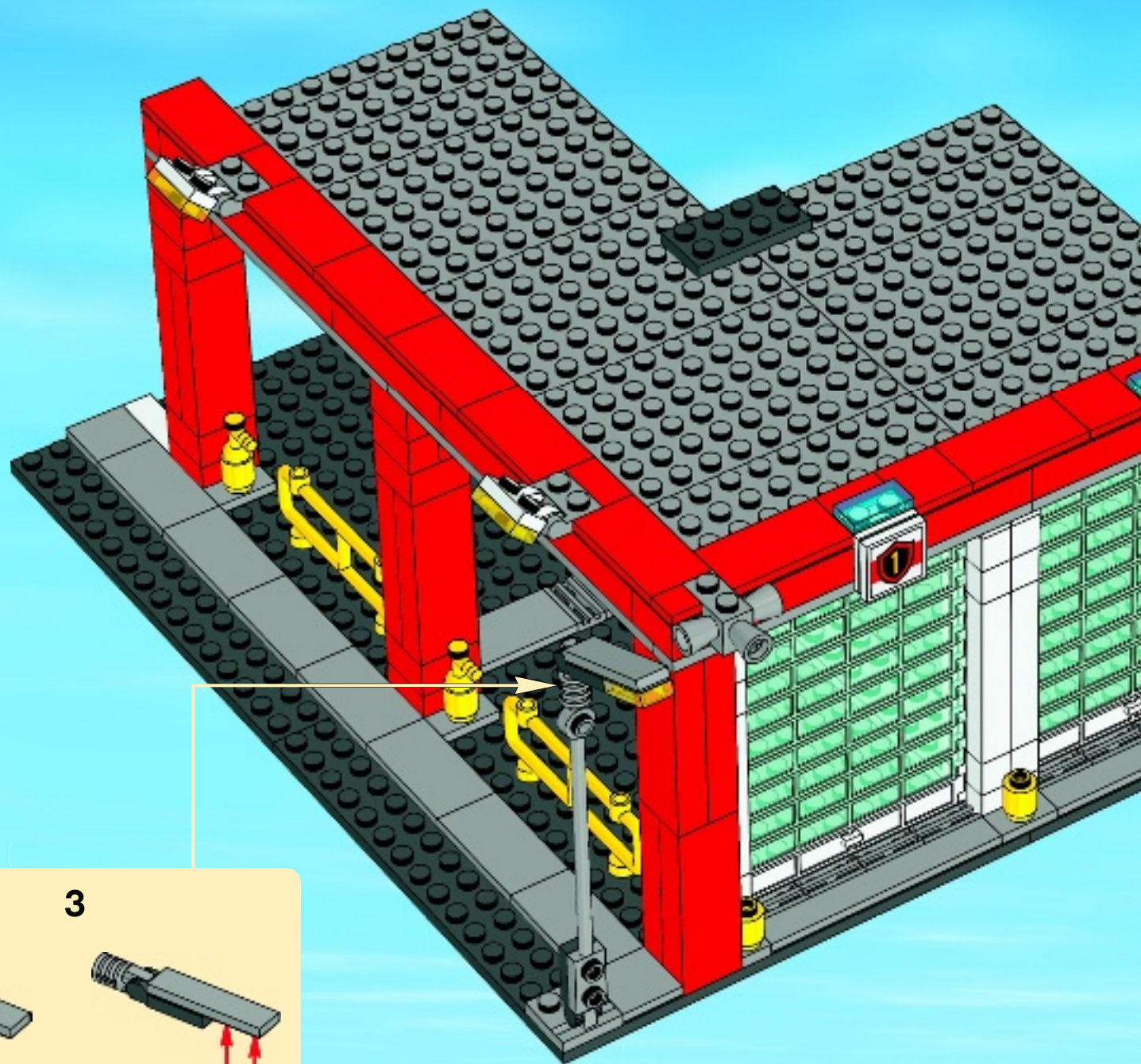

1

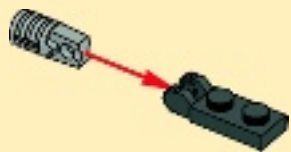

2



3

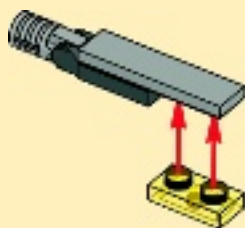

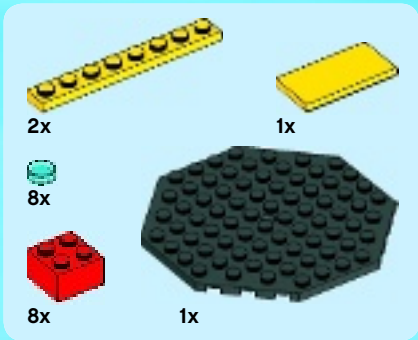

101

1



2



3

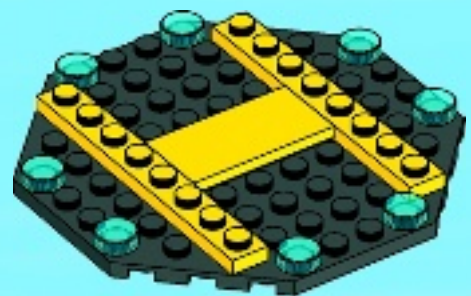



4

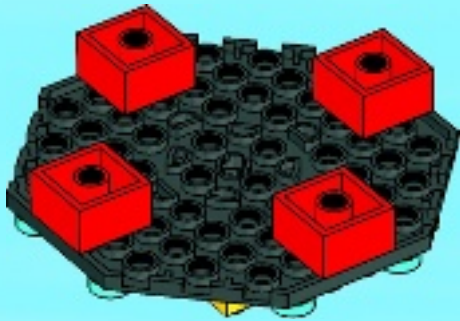

5

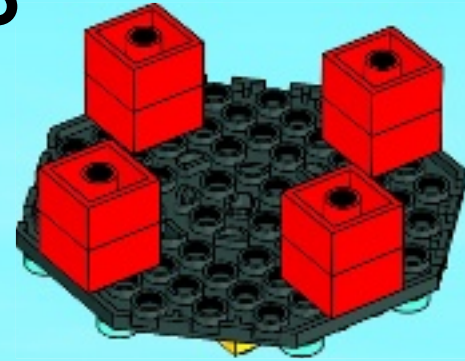

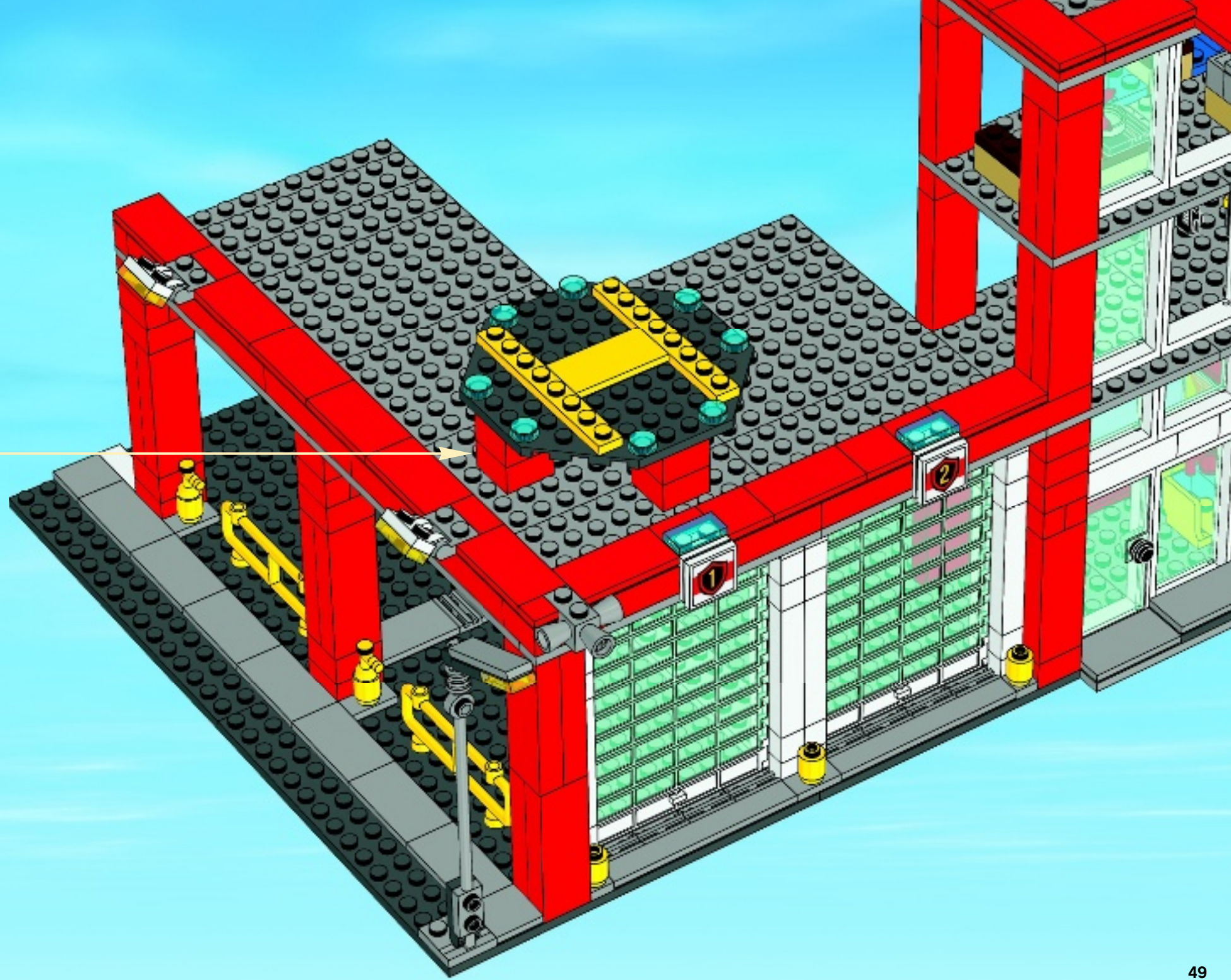



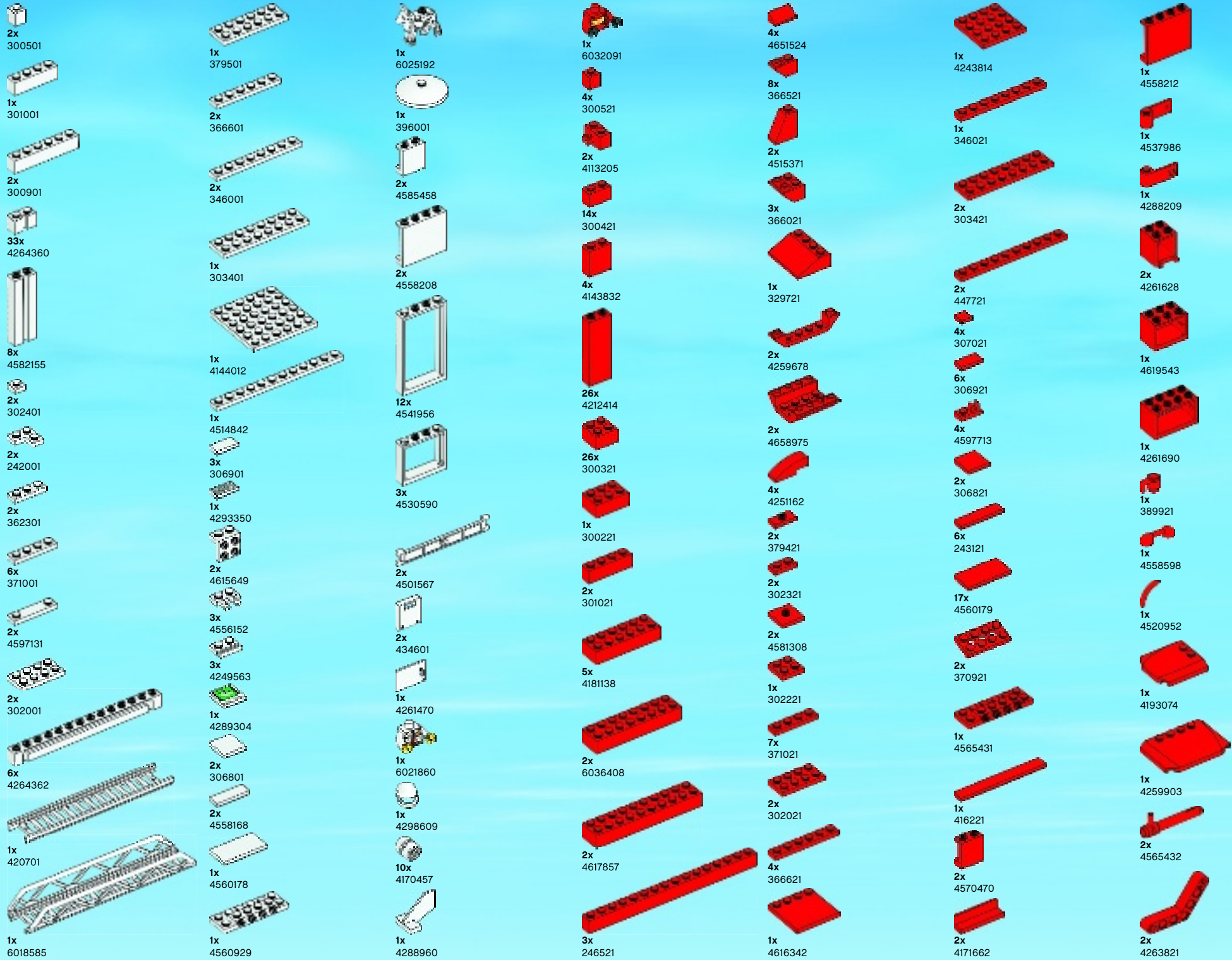

- 4x 6021835
- 3x 4525464
- 6x 306224
- 1x 6020505
- 1x 6050850
- 2x 379424
- 1x 306924
- 1x 4556156
- 1x 4560181
- 2x 379524
- 2x 346024
- 1x 403224
- 3x 4256320
- 1x 407924
- 1x 4558851
- 1x 4262022
- 1x 6020491
- 2x 4189225
- 2x 74156
- 1x 6021675
- 1x 6022320
- 1x 4651443
- 1x 6018502
- 1x 4654328
- 3x 389924
- 1x 383824
- 1x 4610288
- 1x 300423
- 1x 300323
- 1x 4181139
- 2x 4212411
- 1x 300723

- 4x 302323
- 1x 302223
- 1x 459923
- 2x 407923
- 2x 243223
- 2x 9566
- 2x 4143005
- 2x 4206482
- 1x 379426
- 4x 302126
- 2x 447726
- 1x 241226
- 2x 4535739
- 2x 244426
- 1x 614126
- 1x 459926
- 1x 9339

- 4x 6018684
- 1x 6018496
- 2x 6018492
- 3x 396226
- 2x 452226
- 2x 383526
- 1x 400626
- 10x 4568644
- 1x 4289255
- 1x 247926
- 1x 393726
- 1x 4124096
- 1x 258426
- 1x 4262023
- 1x 4517986

- 1x 4512363
- 1x 4107085
- 2x 4211399
- 3x 4211398
- 4x 4211451
- 2x 4211452
- 2x 4211838
- 1x 4251149
- 10x 4211462
- 1x 4514846
- 6x 4166618
- 6x 4211405
- 2x 4662161





- 4x 4211506
- 2x 4215513
- 2x 4565433
- 1x 4211388
- 3x 6015344
- 2x 4211676
- 12x 4211350
- 1x 4654580
- 5x 4244627
- 1x 4666449
- 4x 4211413
- 3x 4211356
- 14x 4560183
- 1x 4565430
- 3x 4211481
- 1x 6010686

-  7x 6018081
-  2x 4211504
-  2x 4211569
-  1x 4223363
-  1x 4211679
-  1x 4211370
-  1x 6004888
-  1x 4211815
-  2x 4613975
-  1x 4211190
-  1x 4211186
-  1x 4520638
-  3x 4650879
-  1x 4567908
-  1x 4626650
-  1x 4654448

-  2x 4211103
-  5x 4210636
-  2x 4264898
-  2x 4239373
-  5x 4567887
-  1x 4648256
-  1x 4211063
-  1x 4546207
-  1x 4259673
-  1x 4583688
-  1x 4654613
-  3x 6004927

-  5x 4211094
-  1x 4211043
-  5x 4211065
-  2x 4211056
-  1x 4211134
-  2x 4587212
-  2x 4210884
-  1x 4225733
-  7x 4210631
-  1x 4568734
-  1x 4211053

-  1x 4528323
-  1x 4261469
-  1x 4211080
-  10x 4260124
-  1x 4624615
-  1x 4551112
-  1x 4114306
-  1x 4113916
-  2x 4114319
-  1x 4114001
-  4x 4244363
-  1x 3005741
-  4x 4260942
-  3x 4194746
-  2x 3005744

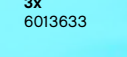
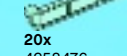
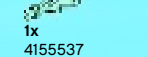
-  9x 6022905
-  1x 4520866
-  3x 6013633
-  20x 4258476
-  1x 4155537
-  1x 4498374
-  1x 6019162
-  1x 4287016

-  1x 4567331
-  2x 4244366
-  12x 4266417
-  2x 4113854
-  1x 4590989
-  16x 4646861
-  1x 3005748
-  2x 4163306
-  4x 4244369
-  1x 4548009

Customer Service
 Kundenservice
 Service Consommateurs
 Servicio Al Consumidor
LEGO.com/service or dial
 : 00800 5346 5555
 : 1-800-422-5346



CITY





club™

Free*! Gratuit!

* Paid subscription in Australia and New Zealand.
Abonnement payant en Australie et Nouvelle-Zélande.



LEGO.com/club



WIN!

Go to LEGO.com/productfeedback to fill out a survey for a chance to win a cool LEGO® Product.
No purchase necessary.
Open to all residents where not prohibited.



LEGO.com/productfeedback

GEWINNE!

Nimm an der Umfrage auf LEGO.com/productfeedback teil und hab die Chance ein cooles LEGO® Produkt zu gewinnen!

Die Teilnahme am Gewinnspiel führt zu keinerlei Kaufverpflichtungen. Teilnahme in allen nicht ausgeschlossenen Ländern möglich.

WIN!

Ga naar LEGO.com/productfeedback, vul een enquêteformulier in en maak kans op een cool LEGO® product.

Geen aankoopverplichting.
Iedereen mag deelnemen, uitgezonderd ingezetenden van landen waar een enquêteverbod geldt.

GAGNE!

Visite LEGO.com/productfeedback pour répondre à un questionnaire et avoir une chance de gagner un produit LEGO® très cool!

Aucune obligation d'achat.
Ouvert à tous les résidents des pays autorisés.

当てよう!

LEGO.com/productfeedback にアクセスして、アンケートにご記入ください。当選者にはレゴ製品を差し上げます。

お買い上げの必要はありません。
禁止されていない限り、すべての皆様にご利用いただけます。



LEGO.com